

	P			
	P X	X	XgX	f
	0		x	
	9		GX	GX f

g X fe f Xgg f X

:L F < \_\_\_\_\_

:L F < G \_\_\_\_\_

0 G \_\_\_\_\_

F < F \_\_\_\_\_ P

	f	<8:	X f e

g gX	f f fe e
Xgg f	e g fe g X X f fe fgp



TRX 特锐祥

: L8 < L 0 8 > <: F F>P < 8 F 8 :F

< Q < < L 0 8 > < <: F : :F

[www.trxc.net](http://www.trxc.net)

Add sc 1  
 Add sz 91 503  
 Tel +86-816-61670387/+86-755-27892117  
 Fax +86-816-6167076/+86-755-27893019

	P		
	P X	X	XgX f
	0		x
	9	GX	GX f

< :

X X eX	P	0 G	
f F	P	X X e	X

	X	< fe	X fe	X
		M <sup>n</sup> fe	X <sup>f</sup> fe e	

f p			Xgg f	
-----	--	--	-------	--



**TRX 特信洋**  
www.trxc.net

: L8 < L 0 8 > <: F F>P < 8 F 8 :F

< Q < < L 0 8 > < <: F : :F

Add sc 1  
 Add sz 91 503  
 Tel +86-816-61670387/+86-755-27892117  
 Fax +86-816-6167076/+86-755-27893019









P			
P X	X	XgX	f
0		x	
9		GX	GX f

fn f f

Y1   F   222   M   064   X   280   A  
 Class   Dielectric   Capacitance   Tolerance   Dielectric diameter   Leads spacing   Leads length   Lead Type

pg P

g X f e f X X P G P L P M

f eX XgX p

P G : XgX p e G=											
: F <											
f eX XgX p											
P L : XgX p e G=											
: F <											
f eX XgX p											
P M : XgX p e G=											
: F <											
f eX XgX p											

: XgX p f X fnX f

G f	P G	P L	P M

	P		f	
	P X	X	XgX	x
	0			
	9		GX	GX f

X

P G											
P L											
P M											

G

P P =  $\phi$  P P x  
 = fe

G e Xg

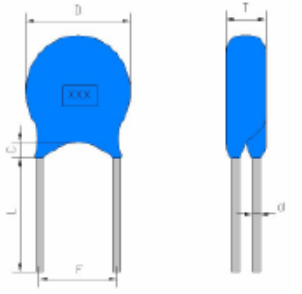
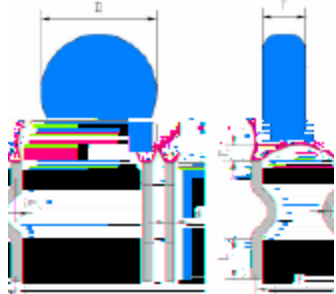
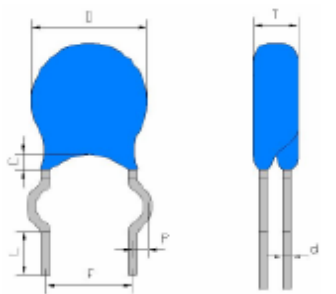
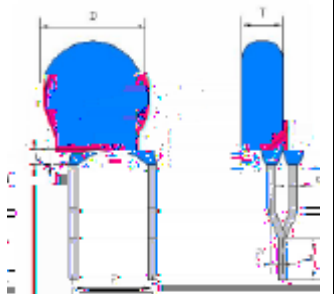
			
8	9	:	

MX f f e fe X f f f gXep Xe X Xgg X fe





f f XeX

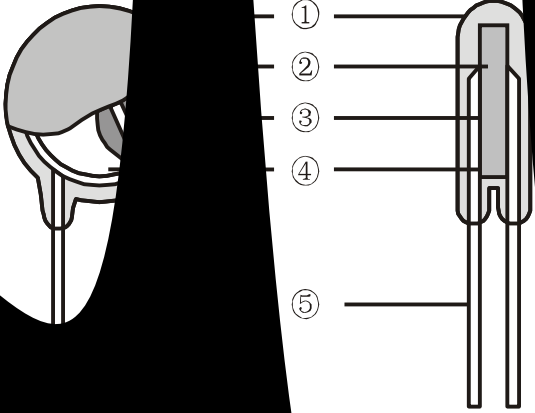

X e

Y110K5

<og X e

X	Xe	
f	e	P
f		9 P G < P L = P M
f X	X	P
f eX XgX	p	
:XgX p f f Xe		
X p X fe X	L	
	:H:	
	< <:	
	M <	
	:	
: M < < <:	M M M8:	
f X f : M < < <:		
L :H:	M	
f X f L :H:		
f f X e		

	P			
	P X	X	XgX	f
	0		x	
	9	GX	GX	f

G f Xe

F		_____
---	--	-------

	P			
	P X	X	XgX	f
	0		x	
	9	GX	GX	f

:fe e

F		G f Xe	
---	--	--------	--

P			
P X	X	XgX	f
	0		x
	9	GX	GX f

: fe e

F		G f Xe	X e f
Xg Xe f g X		X oX eX fe	f X X
		f X g ff	X f
		:XgX Xe	P G P L P M
		gX fe X f	P G ∅ P L ∅ P M ∅
		e X fe Xe	X f
M X fe		:XgX f X ef X X	= h e p Xe  n e f X X fe X f  X fe f ogf X 0 P Q f 0 P Q
X g X X p X		X oX eX f e	f X X
		:XgX Xe	: o : :
		f X g ff	X f
		e X fe Xe	o
			g X ≥ p X fe " f f X M8: L f fe X f X g L M XgX f X g X X ≥ f f f X e ≥

P			
P X	X	XgX	f
	0	x	
	9	GX	GX f

:fe e

F	G f Xe	X e f
g f X	f g Xe e X fne f X f e g f	
	Xep g X fne p f f fg fe f f X X XnX f e X e X ef X e X fn e f X f X X e g X e XgX f e ef g X Xgg Xe XgX f X f e X fe f e	G X g f X M g Xe fe
	X g X e Xgg f XgX f Xe f f f X f X nX f e X e X ef X e X fne f X f X f e XgX f X f e X fe f e	g
	Xe g X f h X f e XgX f X f e X X efe fe f e	
	x	

P			
P X	X	XgX	f
	0	x	
	9	GX	GX f

: fe e

F		G f Xe	X e f
<e Xe		$\begin{matrix} X \\ oX eX f \\ e \end{matrix}$	$\begin{matrix} f & X & X \\ & & \end{matrix}$
		:XgX Xe	:o: :
		$\begin{matrix} f X \\ g ff \end{matrix}$	X f
		$\begin{matrix} e X fe \\ Xe \end{matrix}$	o
: X Xe X		:XgX Xe	:o: :
		$\begin{matrix} e X fe \\ Xe \end{matrix}$	o
GX X X p		$\begin{matrix} X f p \\ e e \\ g e X ef o \\ g \end{matrix}$	$\begin{matrix} 9 \\ f Xep \\ & & \end{matrix}$
		$\begin{matrix} 9 e e fg f fn e \\ gX X e fne X ef \\ e \\ gXg \\ x \end{matrix}$	$\begin{matrix} X f p \\ 9 \\ f Xe \\ X \\ Xo \\ e e \end{matrix}$
			M
			M
			M

$$R = \frac{220 \cdot 10^{-6}}{C_R} \Omega$$

$$:XgX f X g X X \geq f$$

		P			
		P X	X	XgX	f
		0		x	
		9		GX	GX f

:fe e

F	G f Xe	X e f
:f gfe e f e Xe	f           X X G f Xe X f	f e f fg fgp X f f Xe           o feX f gf e  f e g X           ≥ XgX f X           e f e f           fe x f p                   f
f e Xe  f X e	X e X	f e f fg fgp X f f Xe           o feX f gf e  f e g X           ≥ XgX f X           e f e f           fe Xe X X n g n g f

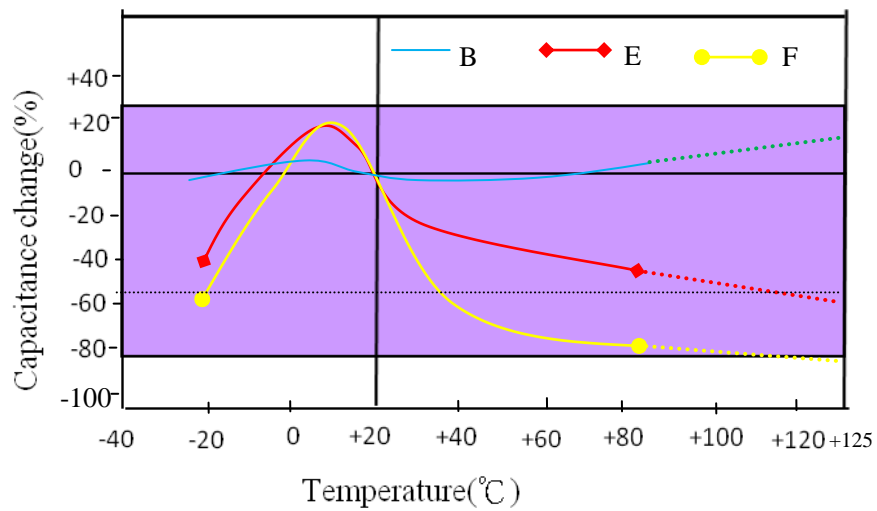



	P			
	P X	X	XgX	f
	0		x	
	9		GX	GX f

: X X f p  
8 f e f < 8 8 8



:X f p g X fn Lgg X f p g X X p X X g X  
e Xp

< e <

< e X e g X f fg X fe :f

e < Xo X e g X f fg X fe p X

< f Xp X g X X p X

:X f p < oX g X f e f <: <:





=	
nf	ef e e X e
g X	f fg X fe :f
	>
	>
	>
	>
	>
	>
	" >

fe	
X e g X	ef e Xo
X	f fg X fe p
	"
	"
	"
	"
	"
	"
	"
	"

nf	
X	ef e e f Xp X g
Xp	Xp X
	Xp
	Xp
	Xp
	Xp
	f gfe e ef
	h f ogf f
	X g X



	P P X X XgX f		
	0	x	
	9	GX	GX f

F	:FL P	8 8 F	: 8 PG< N M : : G = :	= < F	8
	>< 8 P <L FG<	M <	< M < < <:	P P 8: M :	 
	L 8 : 8	L :L	L : 8 <	P P 8: M 9	< 
	: 8	:H:	<:	P P 8: M 9	:H: 
	F <8	:	: :	P P 8: M 9	L 8 

h e f fe e X fe f X e X X f Xe

f <L

X f e

<8: f

**RoHS H.F.  
REACH**

Xe	fe e X fe e gg
:X Xe X f gf e	
X Xe X f gf e	
p Xe p f gf e	
oX X e f f gf e	
Gf f eX g ep G99	
Gf f eX g ep G9 <	
: "G " " : " gX e X X " " "	
:	
9	
: "9 "	
M : <8:	



P			
P X	X	XgX	f
	0		x
	9	GX	GX f

GX e

8

< F	X e	9X
	f	G:
		G:
	G:	

9 8G< G: 9F0

: XgX f fe Xg pg g

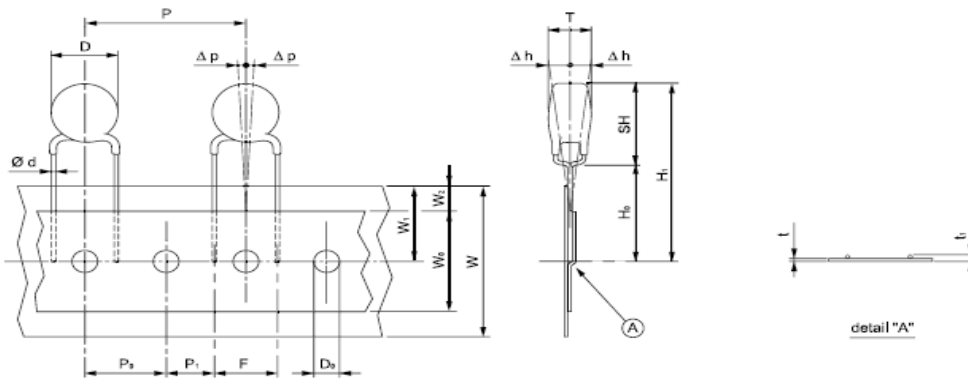

GX X	p f	Xg e g X fe		
		G	G	f Xe
X X				
g n e XgX f	g			
f g	G			
f e f X e	G			
X gX e	=			
f gfe e X e e				
X fe X fe Xg f	g			
Xg n	n			
f fne Xg n	N			
f gf fe	N			
f fne Xg gf fe	N			
X f Xg e				
Xo f gfe e				
f X				
f X Xg e				
Xo e f Xg Xe n				

	P		
	P X	X	XgX f
	0		x
	9	GX	GX f

:X fe Xe nX e e

8 e fe Xne f X X g fe f f X g ff p Xp X X  
XgX f

f ef g X XgX f X G: fX n f f gX f g X gX  
G: 9 G: 9 G: 9

8 f Xep f g e f o X x  
G X fe pf n f XgX f e g X e

f ef f XgX f X X e f f fX  
G: 9 x

f ef g g G: fX p f XgX f x

Mf X g ff

8 :f f



Fg X og X e

g f X e Xe e f X e e  
x

nf g e f XgX f X e gg e o f f X e e

> X fe X g Xe XgX f Xe Xe f X e e  
fg f g n e X

9 < f f x



Fg X og X e

:XgX f nX n f X g f f f f nf g e f XgX f  
x



P			
P X	X	XgX	f
	0	x	
	9	GX	GX f

e X efn f X : XgX f

f XgX Xe Xe gX fe X f Xe  
 XgX f X X g n ff Xe X XgX f  
 ef efe f n Xe : XgX Xe Xe gX fe X f X ef oX X  
 f g X e Xe Xe ef  
 x

x  
 XgX f XgX Xe Xe gX fe X f X f X Xp ef  
 f XgX f f f f X f X XgX f  
 X n e X f f f X f Xe X X e  
 XggX X

x  
 f Mf X g ff  
 : X f XgX f X 8: f : Mf X X Xe e X e  
 XggX X X g e XgX f X n X g f XggX X f g gX n e  
 X g f XggX X f g Xe X f X f n Xgg e  
 n e nf X gX ff X : XgX f fe X fe nX fp  
 X e n Xgg e e XgX f f f e

x



P  
P X X XgX f

0

x

9

GX

GX

f

f X

e

<: = o XgX f f e fe h g e GX > e g X fe

<: = o XgX f f e fe h g e GX feX

g X fe = o XgX f f f X e e e gg fe Xe fee fe f  
gg p X e

>9 <: = X X e f fe g f GX

f fe X

>9 <: = o XgX f f e fe h g e

GX > e g X fe

>9 F X g e g f f e g fe p X  
GX X g e e o p X g Xe h X p 8H f f f e g fe  
8H

>9 <: G e f f Xe XgX f

>9 <: X e f f f Xe XgX f

A h e f fe e X fe f X e X X f Xe e  
fe e f X fe g f

A X e f fe f f gf fe X p fe e f X fe g f

A e f f X X f Xe e fe e f X fe g f

<L f fe f f X e X X f Xe e < X  
Xe < fe <h g e

<: N<<< NX < X Xe < fe <h g e

<: < fg GX X e Xe :f e <: f fe  
GX X e Xe gX X e nX

<:

f <8: X fe < X X fe 8 f X feXe fe f : X

w w