



-10

A B A3 F
: _____

H G ,L G D , □ □ ,G ,518172

1.

(1) C

(C : 50 600% IF = 5 A, CE = 5)

(C : 63 320% IF = 10 A, CE = 5)

(2) H □ - (= 5,000)

(3) H □ - (CE = 70)

(4) -55 110

(5) C > 8

(6) E □

(7) L - : 2.3 : -10

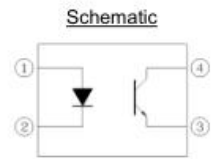
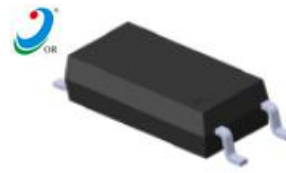

Schematic

- Pin Configuration**
 1. Anode
 2. Cathode
 3. Emitter
 4. Collector

2.

-10

4-

3.

(1)

(2)

(3)

(4) H , □ □ , .

(5)

(2)

		60	
		125	
		6	
		100	
		0	
		7	
		50	
		150	
		250	
*1		5000	
		-55 + 110	
		-55 + 125	
*2		260	

*1 1 , . . . 40 60% . . , 1,2 , 3,4 .

* 2 10

2

	F C		50	---	1.25	1.6	
			4	---	---	10	
	C		0, 1	---	50	---	
	C C		20 0	---	10	100	
	C E		1 0	0	---	---	
	E C		0.1 0	7	---	---	
	*1 C		5	50	---	600	%
	C C		5	2.5	---	30	
	C E	()	10 1	---	---	0.3	
	I I		500 40 60% . . .	10 ¹²	---	---	
	F C		0, 1	---	0.3	---	
			5 2	---	3	1	
	D		100	---	4.7	1	

*1 C C = I_C / I_F 100%, C : 3%.



C	.	.	C
-1000	50	600	
-1001	100	160	
-1004	100	200	
-1005	50	150	
-1006	100	300	
-1007	80	160	% IF=5 A, CE=5 , =25
-1008	130	260	
-1009	200	400	
-1010	150	300	
-1019	250	500	
-1020	300	450	
-1002	22		

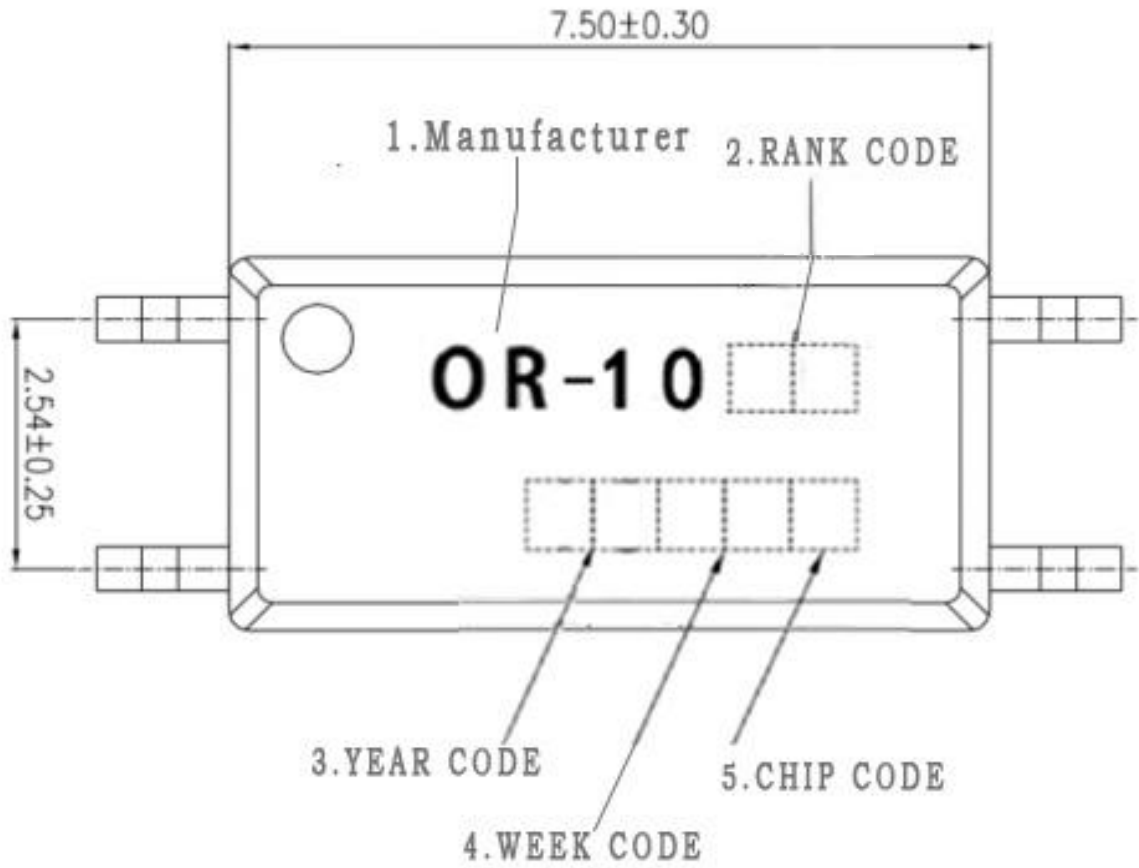

- (1) □ □ □ L . C ., L .
- (2) □ □ C .
- (3) □ □ .
- (4) □ □ .
- (5) □ C □ C
- (6) -10 D
- (7) :

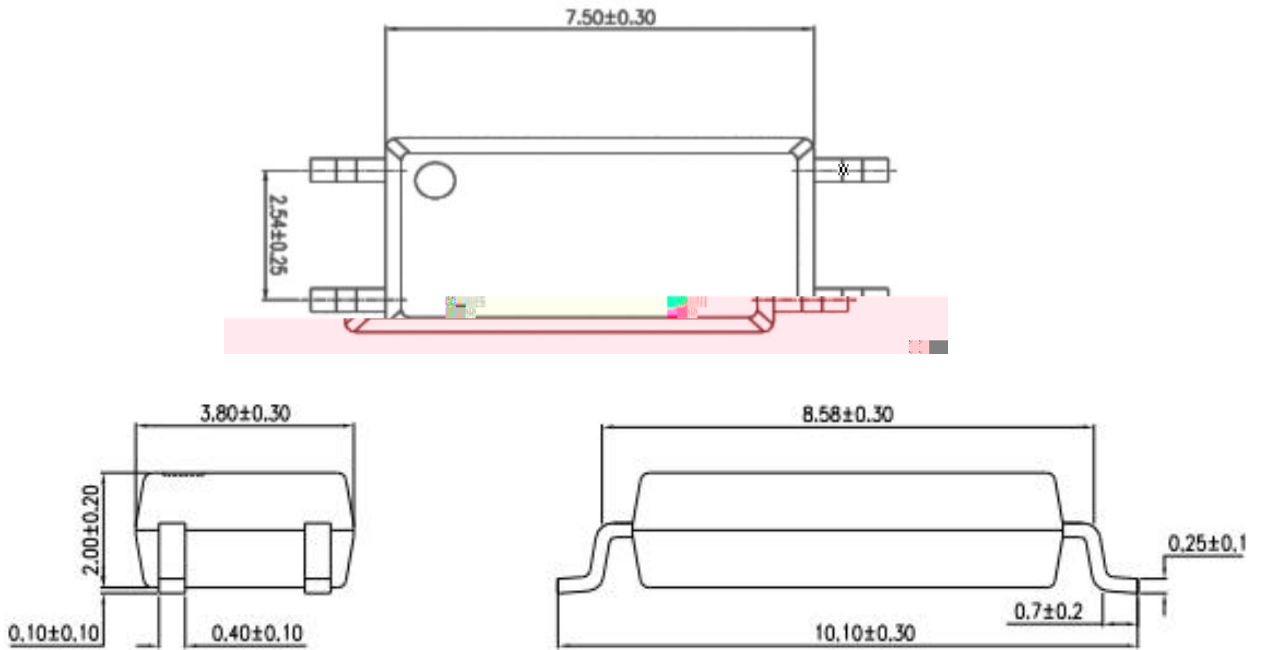

()

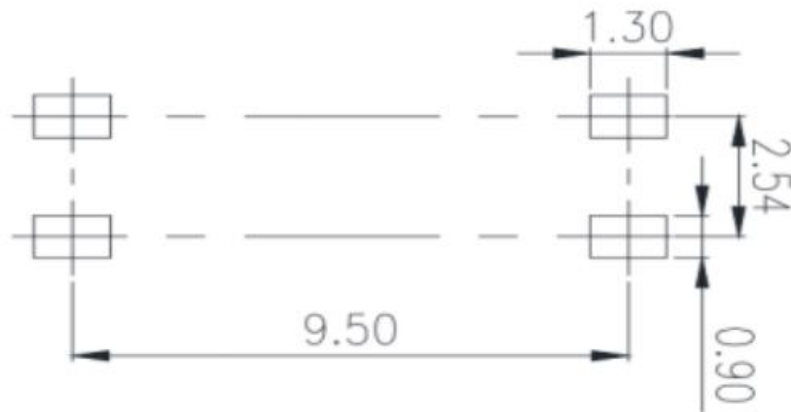

(1) -10 -

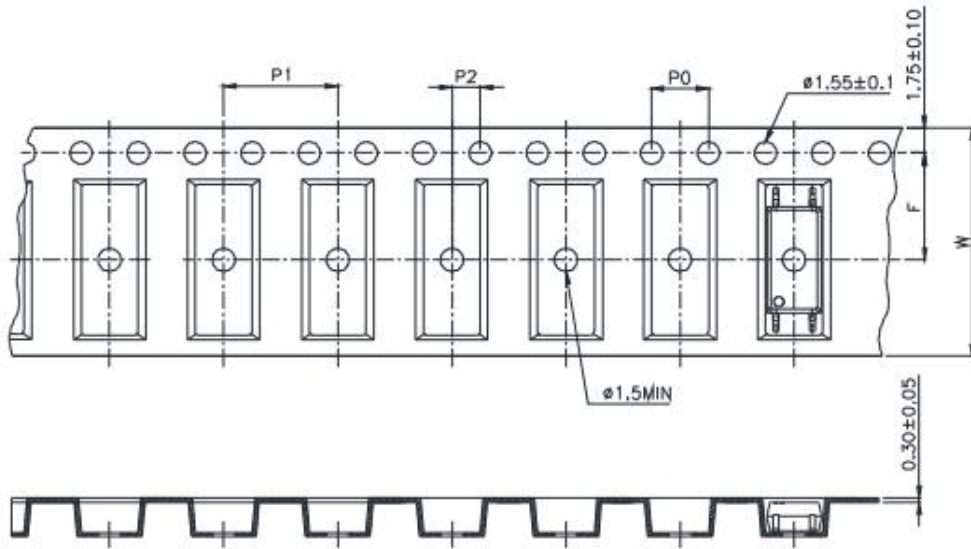

(2) -10 - 1

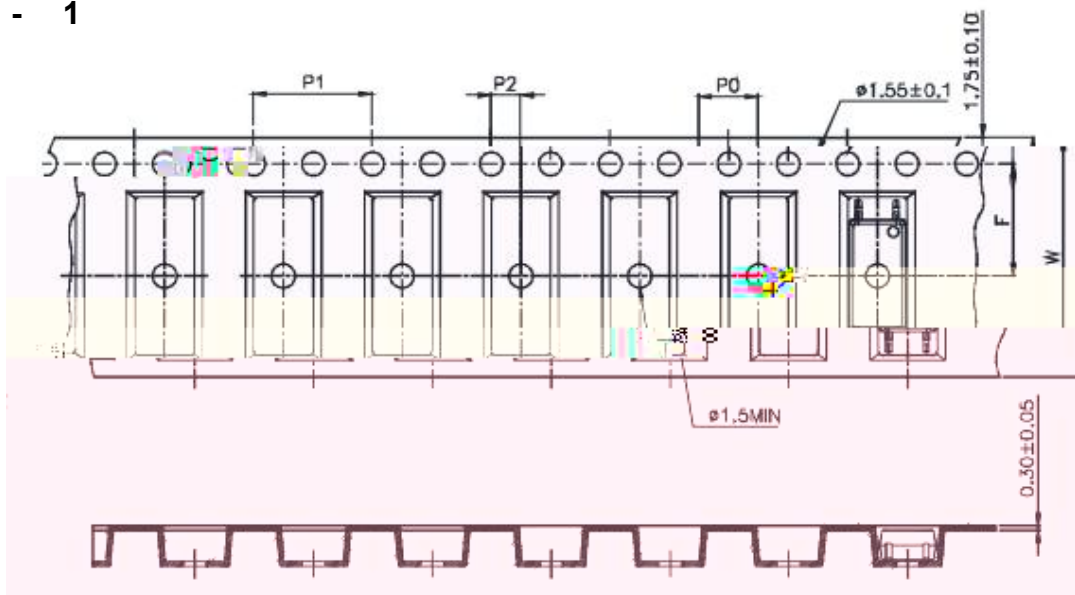

D		D (□)
		16 0.3 (0.63)
□ □	0	4 0.3 (0.15)
D	F	7.5 0.1 (0.295)
	2	2 0.1 (0.079)
D	1	8 0.1 (0.315)

	-10 (/ 1)
()	3000

11.

(1). (- -020)

.D

	C
- ()	150 C
- ()	200 C
- () ()	90 30
- (L)	217 C
- (L)	60
()	260 C
-	3 C / .
-	3 6 C /

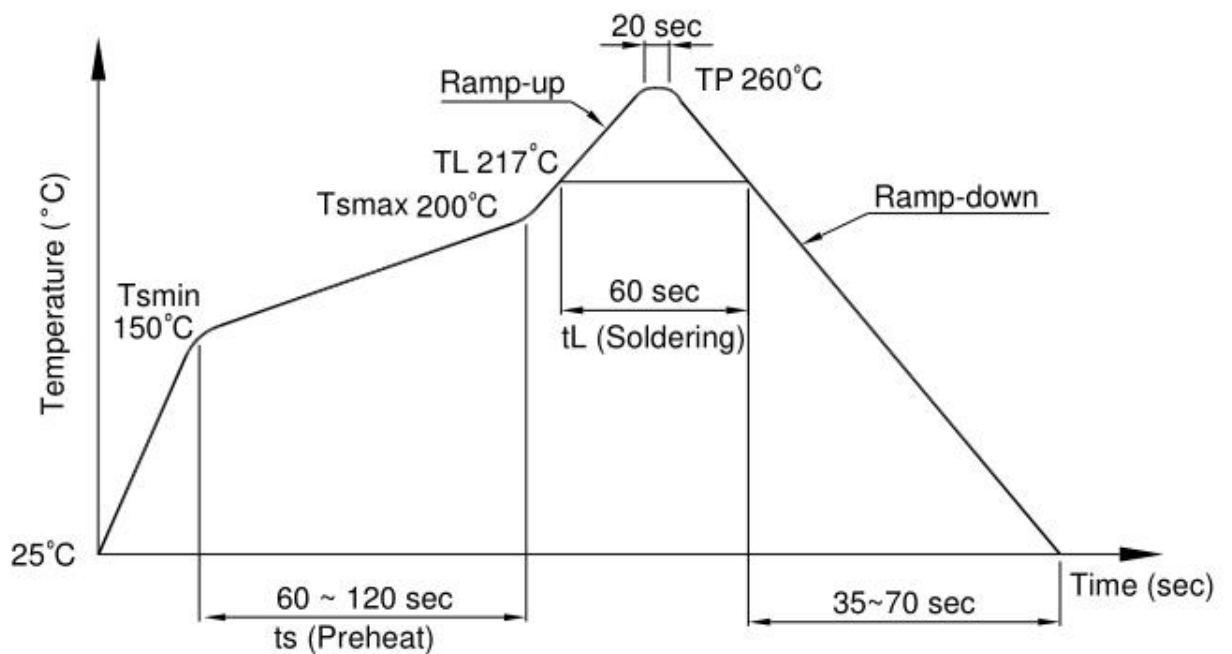

12.

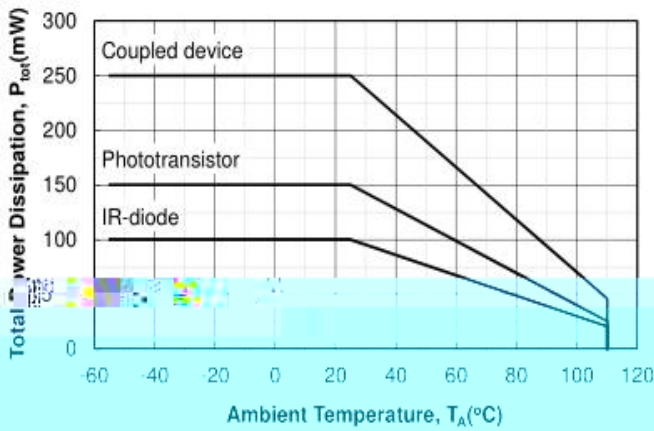

Figure 1. P_{tot} vs. T_A

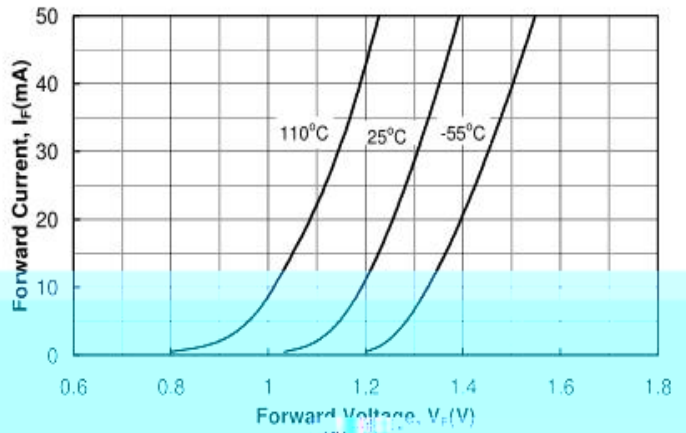

Figure 4. I_F vs. V_F

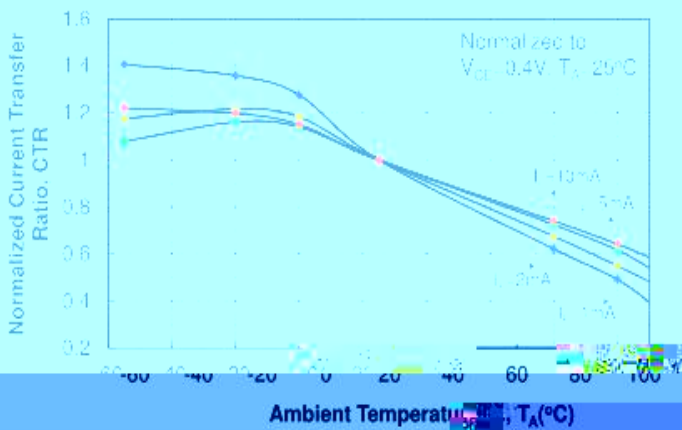

Figure 2. Saturated Normalized CTR vs. T_A

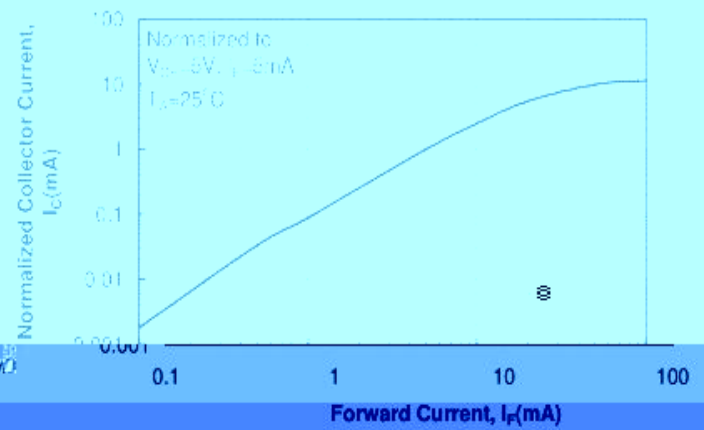

Figure 5. Normalized I_C vs. I_F

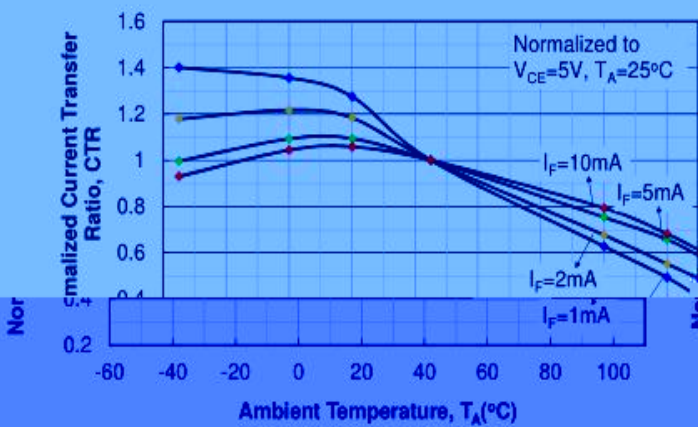

Figure 3. Non-saturated Normalized CTR vs. T_A

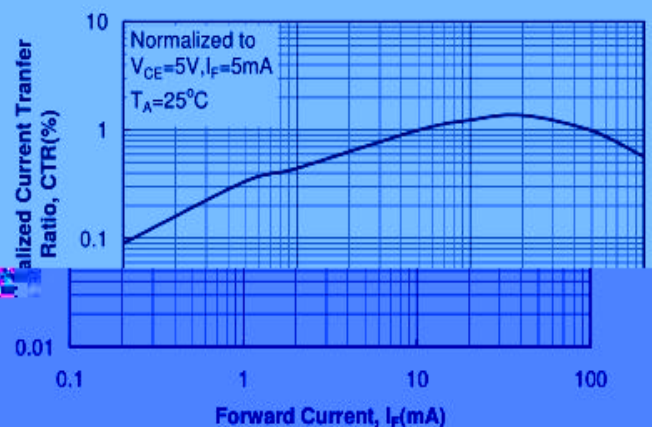

Figure 6. Normalized CTR vs. I_F

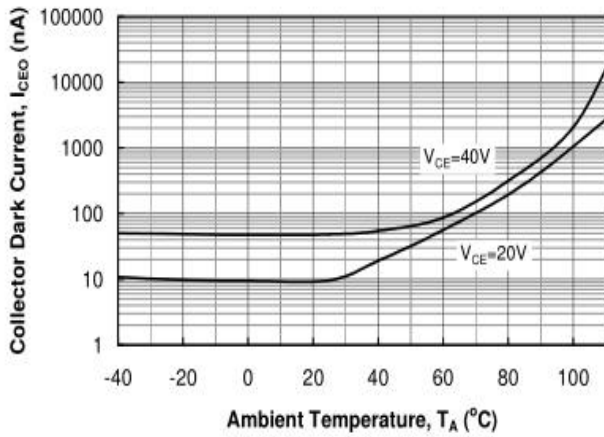

Figure 7. I_{CEO} vs. T_A

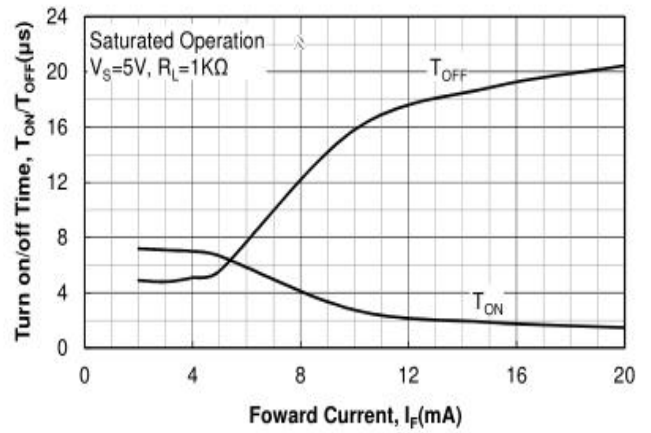

Figure 10. T_{ON} / T_{OFF} vs. I_F

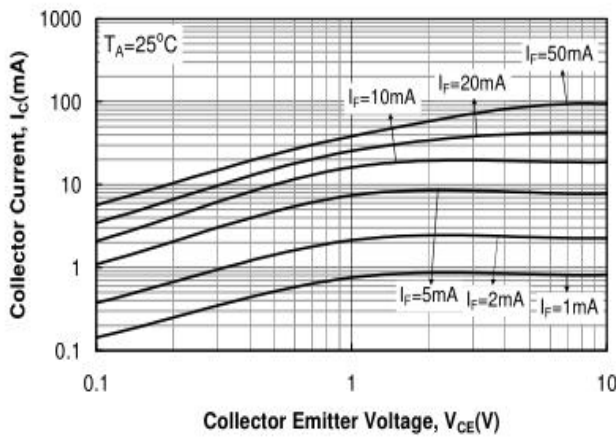

Figure 8. I_C vs. V_{CE}

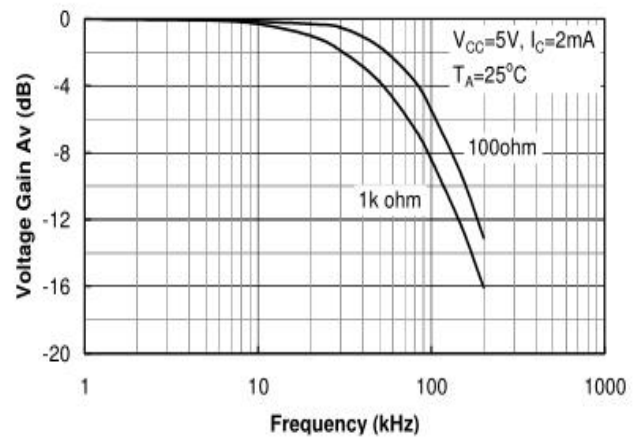

Figure 11. Frequency Response

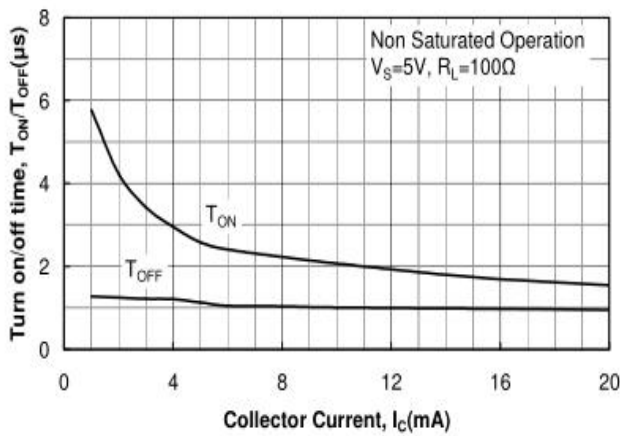

Figure 9. T_{ON} / T_{OFF} vs. I_C



IE □ , , □
IE □ □ □ □ □
□ □ , □ □ □
□ □ □ □ □ □ IE
□ □ □ □ □ □ □
□ □ □ □ □ □ □
I □ □ □ □ □ □ □ □ □ □ □