

### FEATURES

Complimentary to S8050

Collector current:  $I_C=0.5A$

MARKING : 2TY

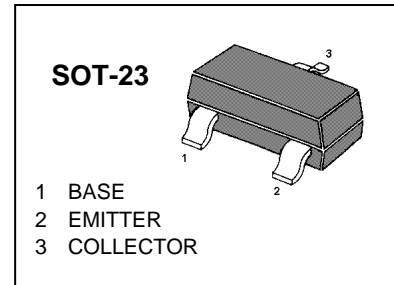

### MAXIMUM RATINGS ( $T_A=25^\circ C$ unless otherwise noted)

Symbol	Parameter	Value	Units
$V_{CBO}$	Collector-Base Voltage	-40	V
$V_{CEO}$	Collector-Emitter Voltage	-25	V
$V_{EBO}$	Emitter-Base Voltage	-5	V
$I_C$	Collector Current -Continuous	-0.5	A
$P_C$	Collector Power Dissipation	0.3	W
$T_j$	Junction Temperature	150	$^\circ C$
$T_{stg}$	Storage Temperature	-55-150	$^\circ C$

### ELECTRICAL CHARACTERISTICS ( $T_{amb}=25^\circ C$ unless otherwise specified)

Parameter	Symbol	Test conditions	MIN	MAX	UNIT
Collector-base breakdown voltage	$V_{(BR)CBO}$	$I_C = -100\mu A, I_E=0$	-40		V
Collector-emitter breakdown voltage	$V_{(BR)CEO}$	$I_C = -1mA, I_B=0$	-25		V
Emitter-base breakdown voltage	$V_{(BR)EBO}$	$I_E = -100\mu A, I_C=0$	-5		V
Collector cut-off current	$I_{CBO}$	$V_{CB} = -40V, I_E=0$		-0.1	$\mu A$
Collector cut-off current	$I_{CEO}$	$V_{CE} = -20V, I_B=0$		-0.1	$\mu A$
Emitter cut-off current	$I_{EBO}$	$V_{EB} = -3V, I_C=0$		-0.1	$\mu A$
DC current gain	$h_{FE(1)}$	$V_{CE} = -1V, I_C = -50mA$	200	350	
	$h_{FE(2)}$	$V_{CE} = -1V, I_C = -500mA$	50		
Collector-emitter saturation voltage	$V_{CE(sat)}$	$I_C = -500mA, I_B = -50mA$		-0.6	V
Base-emitter saturation voltage	$V_{BE(sat)}$	$I_C = -500mA, I_B = -50mA$		-1.2	V
Transition frequency	$f_T$	$V_{CE} = -6V, I_C = -20mA$ $f=30MHz$	150		MHz

# Typical Characteristics

---

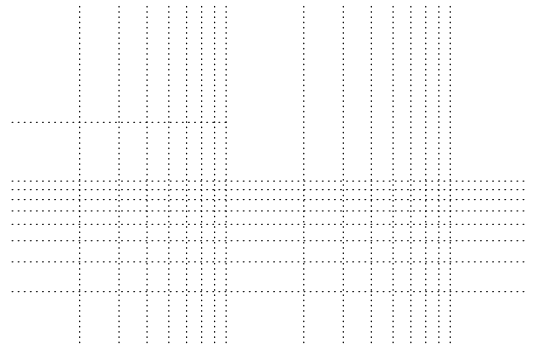
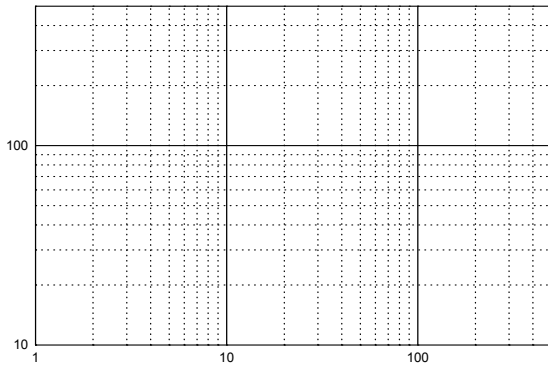
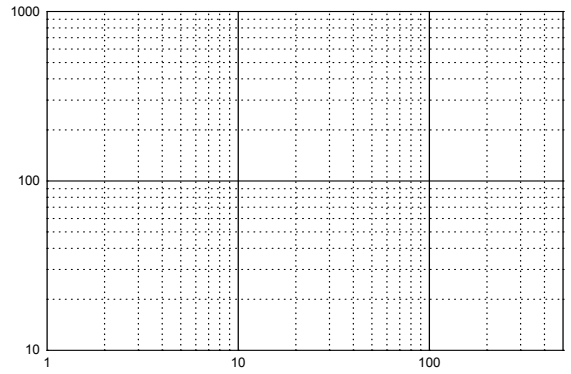

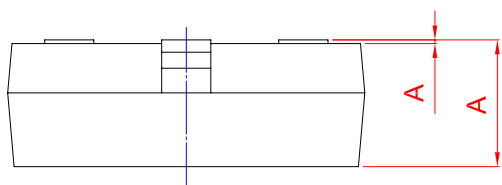
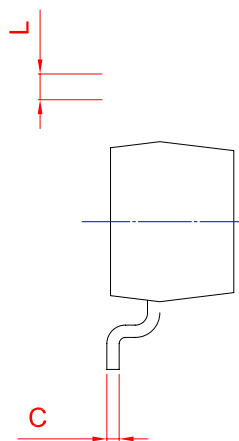
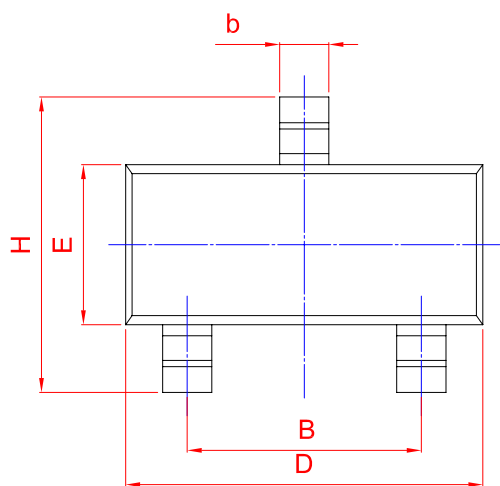

<b>UNIT</b>	A				D	E		A <sub>1</sub>	
<b>mm</b>	1.40 (								