

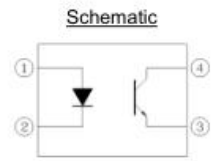

-10

1.

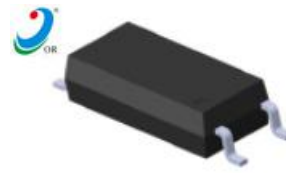

Pin Configuration

- 1. Anode
- 2. Cathode
- 3. Emitter
- 4. Collector

2.
3.

-10

4-

(2

			60	
			125	
			6	
			100	
			0	
			7	
			50	
			150	
			250	
*1			5000	
			-55 + 110	
			-55 + 125	
*2			260	

*1 1 , . . . 40 60% . . . , 1,2 , 3,4 .

* 2 10



2

			50	---	1.25	1.6	
			4	---	---	10	
			0, 1	---	50	---	
			20 , 0	---	10	100	
			1 0	0	---	---	
			0.1 0	7	---	---	
			5	50	---	600	%
			5	2.5	---	30	
		()	10 1	---	---	0.3	
			500 40 60% . . .	10 ¹²	---	---	
			0, 1	---	0.3	---	
			5 , 2	---	3	1	
			100	---	4.7	1	



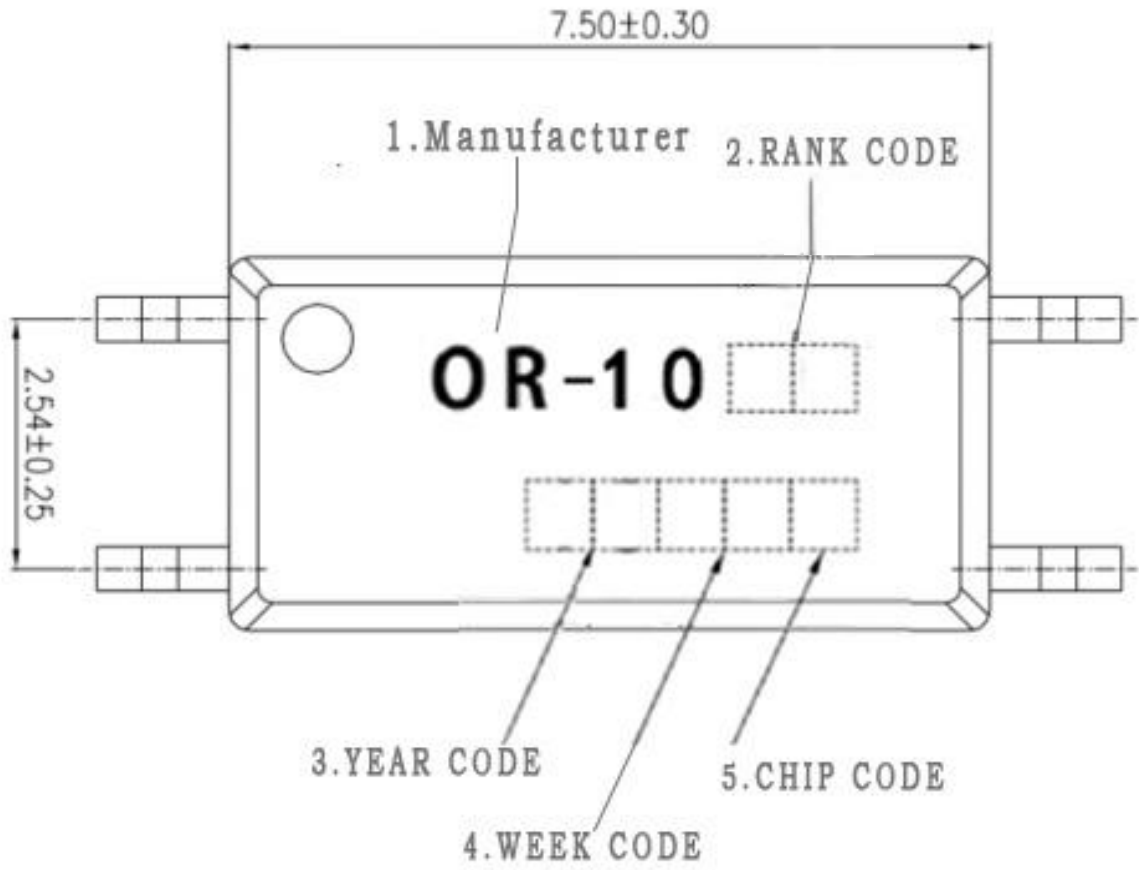

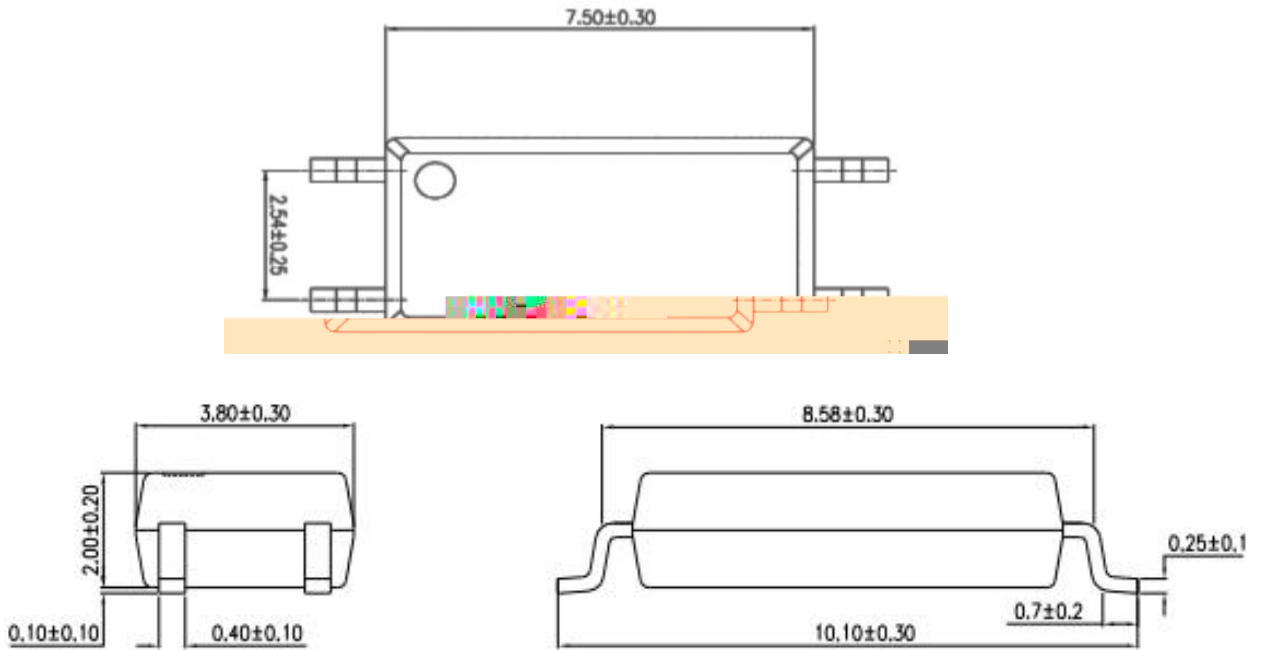

()

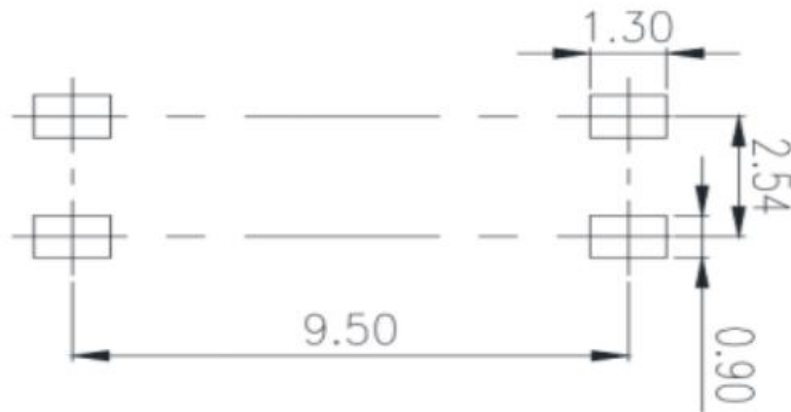

(1) -10 -

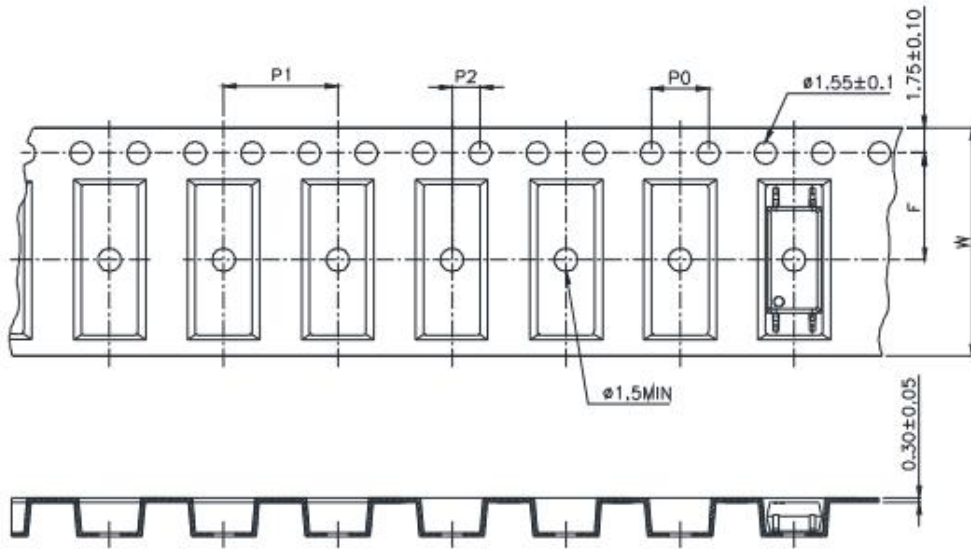

(2) -10 - 1

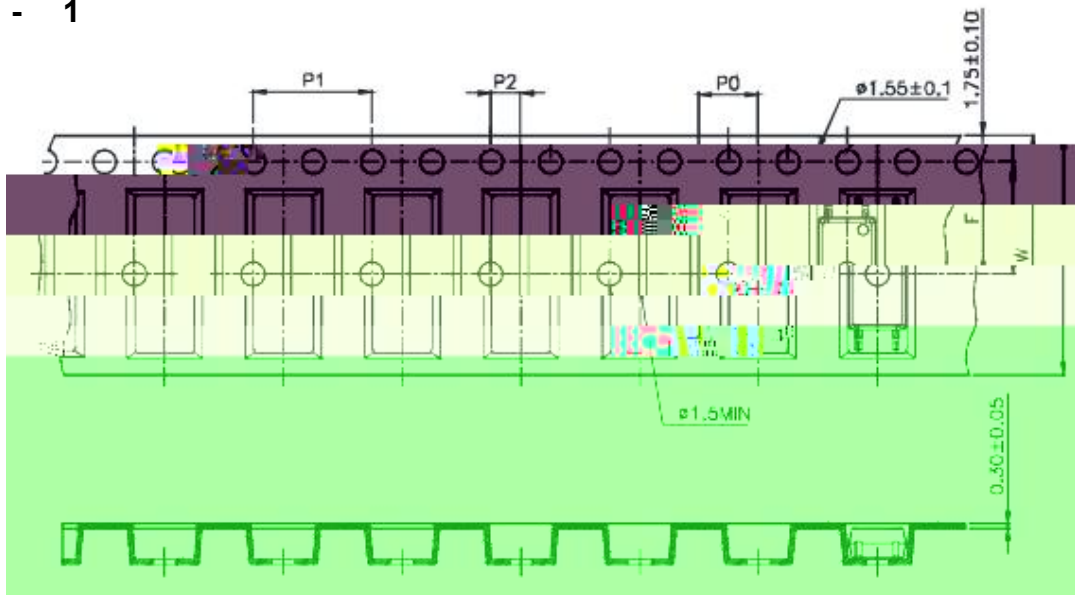

11.

(1). (- -020)

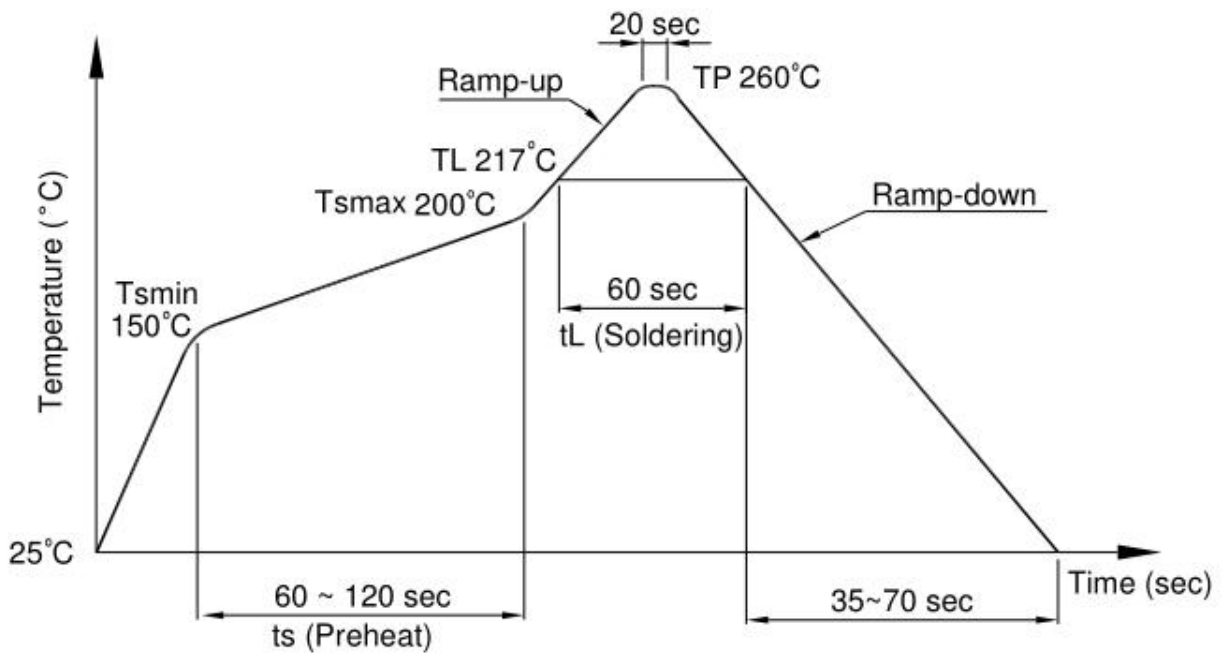

(2). (22 111)

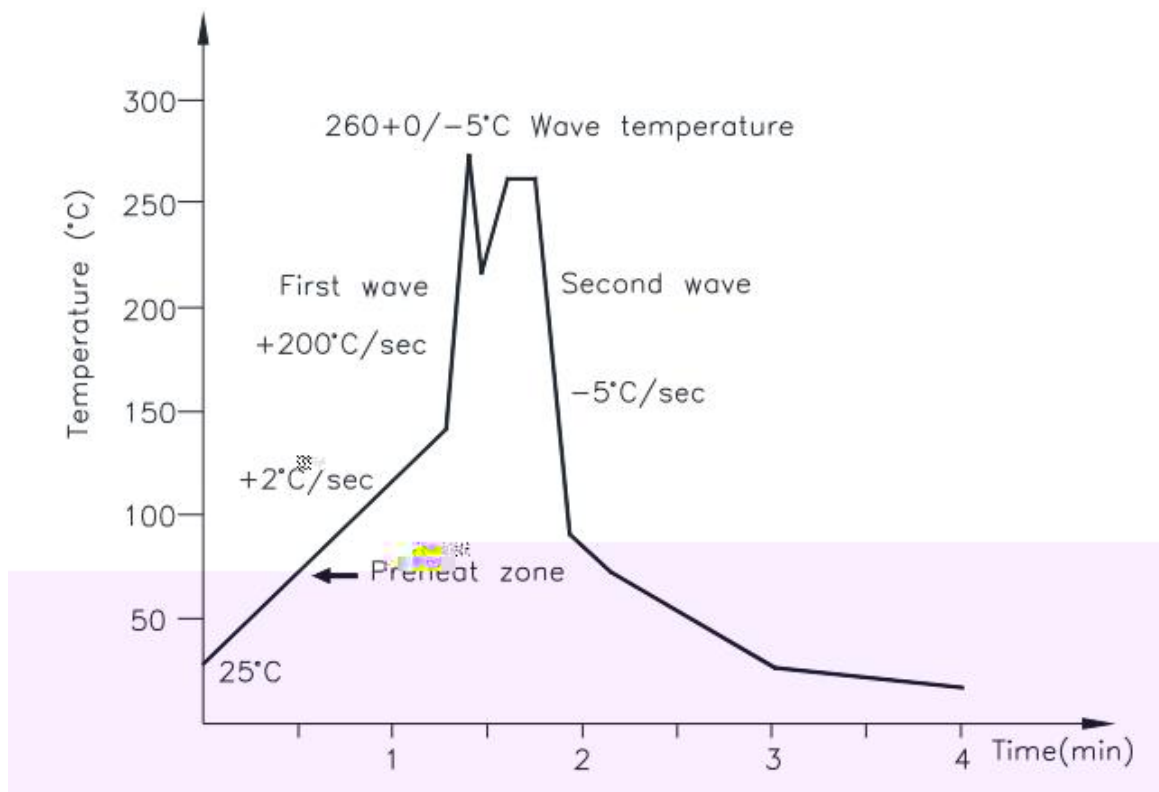

(3).

--	--

12.

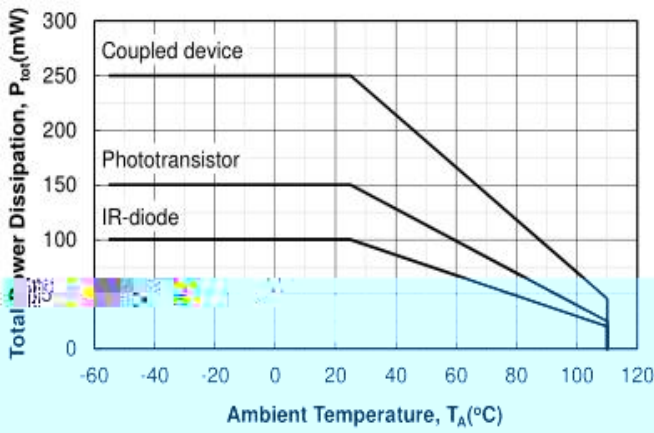

Figure 1. P_{tot} vs. T_A

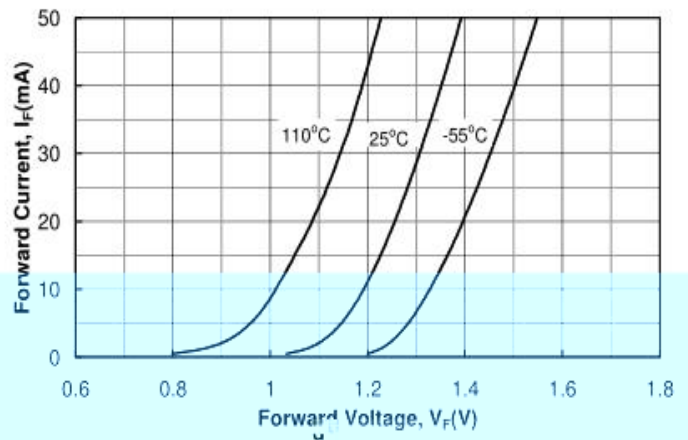

Figure 4. I_F vs. V_F

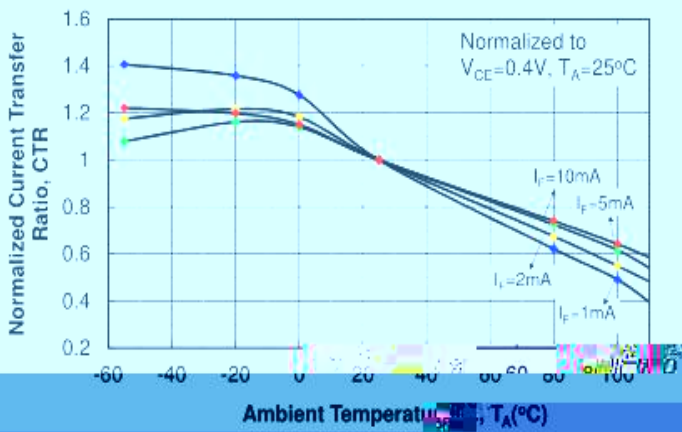

Figure 2. Saturated Normalized CTR vs. T_A

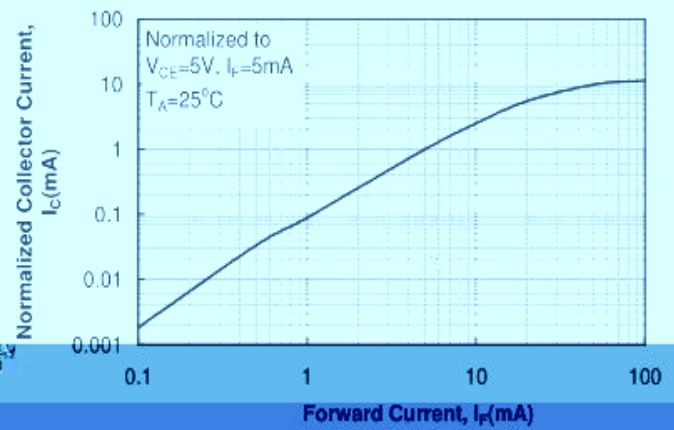

Figure 5. Normalized I_C vs. I_F

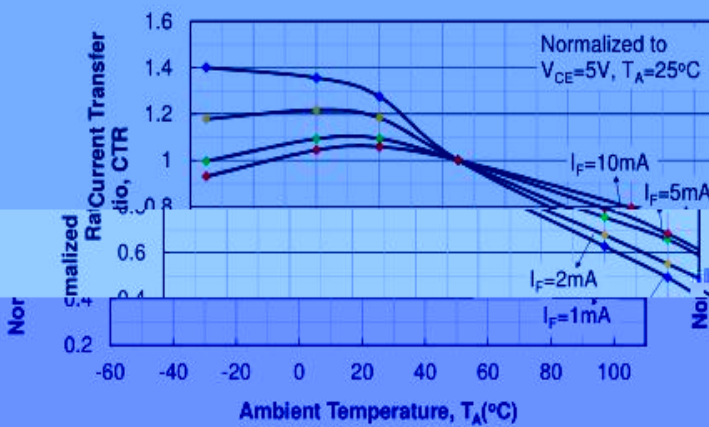

Figure 3. Non-saturated Normalized CTR vs. T_A

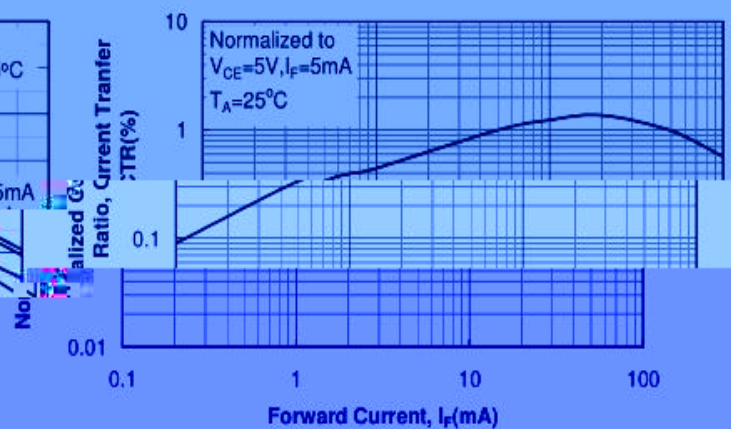

Figure 6. Normalized CTR vs. I_F

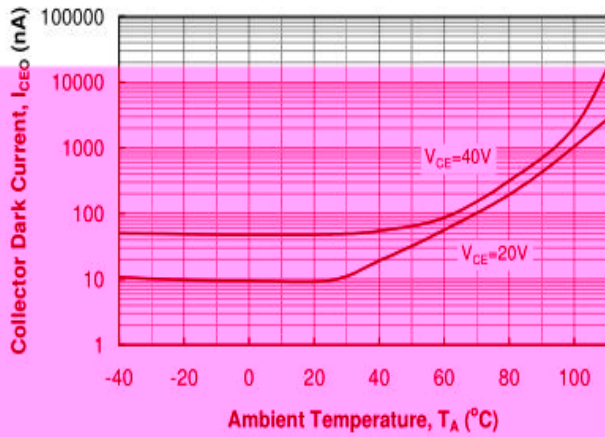

Figure 7. I_{CEO} vs. T_A

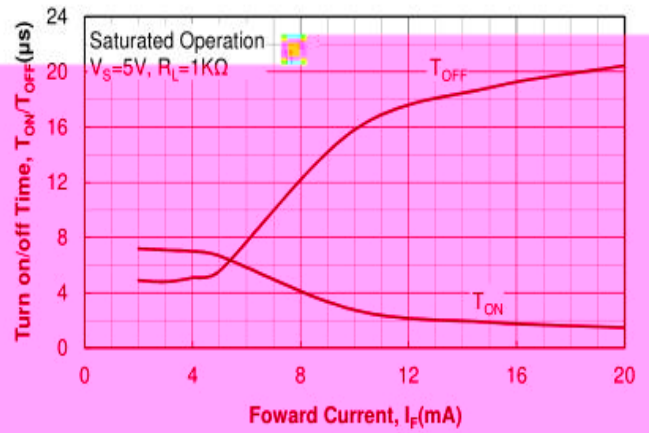

Figure 10. T_{ON} / T_{OFF} vs. I_F

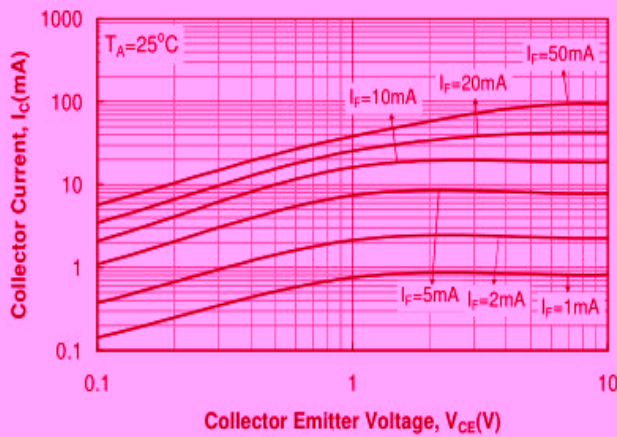

Figure 8. I_C vs. V_{CE}

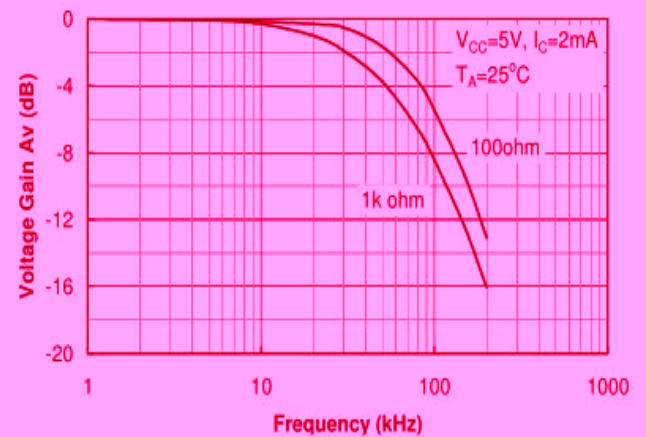

Figure 11. Frequency Response

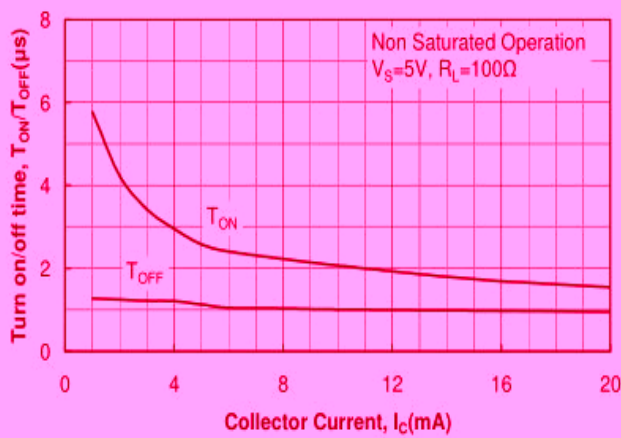

Figure 9. T_{ON} / T_{OFF} vs. I_C

