

# 深圳市弗瑞鑫电子有限公司

## 规格承认书

—  
————  
————

prepare	
check	
approve	



TRX电容一级代理商

深圳市弗瑞鑫电子有限公司

Add:深圳市宝安区西乡大道302号金源商务大厦B座3楼

Tel:0755-29563634

Fax:0755-27447020

- 2

2 . .

/	-3-082	/	2021-11-15
/	A1	/	P 3 18

 <b>TRX</b> 专注电容器廿年	- 2 2 . .			
	/	-3-082	/	2021-11-15
	/	A1	/	P 4 18

## /CON EN

1.	P N	-----	5
2.	P	-----	5-6
3.	D	-----	6
4.	C	-----	7
5.	P	-----	7-8
6.		-----	8-9
7.	P	-----	9-14
8.	C	-----	14
9.	C	-----	15
10.		-----	15
11.	P P	-----	16-17
12.	A	-----	18

	- 2 2 . .			
	/	-3-082	/	2021-11-15
	/	A1	/	P 5 18

1. /

① ② ③ ④ ⑤ ⑥

N . C

E

①

L

 <b>TRX</b> 专注电容器廿年	- 2 2 . .			
	/	-3-082	/	2021-11-15
	/	A1	/	P 6 18

3. /



		2020	M	1	01	1	01	16	16
		2021	N	2	02	2	02	17	17
2010	A	2022	P	3	03	3	03	18	18
2011	B	2023		4	04	4	04	19	19
2012	C	2024		5	05	5	05	20	20
2013	D	2025		6	06	6	06	21	21
2014	E	2026		7	07	7	07	22	22
2015	F	2027		8	08	8	08	23	23
2016	H	2028		9	09	9	09	24	24
2017	J	2029		10	10	10	10	005	

4. /

C		C	C
L/C L	L/C A 60384-14	E315719	AC300 ( . . . )
C C	GB/ 6346.14-2015	C C20001280609	AC300 ( . . . )
ENEC	EN 60384-14:2013/A1:2016	ENEC-03177	AC300 ( . . . )
KC	K60384-14	H 03034-21003A	AC250 ( . . . )

5. /

5.1 /P D

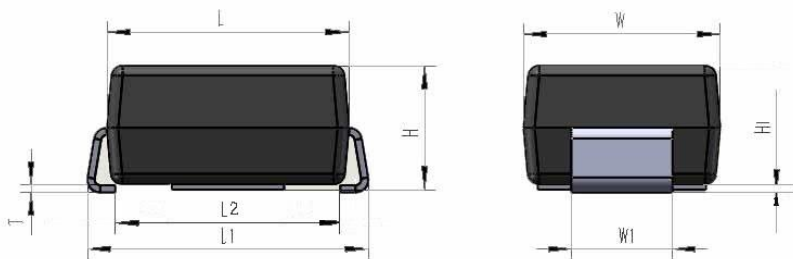

P		D		( )	
L	4.3 0.1			3.5 0.3	
L1	5.0 0.1	L2		4.0 0.1	
H	2.2 0.1	1		1.8 0.05	
H1	0.1 0.05			0.13 0.02	

5.2 /P

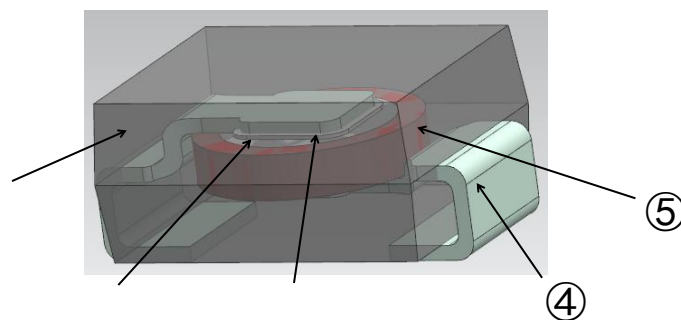

N .	P	M
①	C	E ( L94 -0) ( L94 -0)
②	E	/C
③		-P -A -P -A
④	L P	
⑤	D	C

5.3 / P

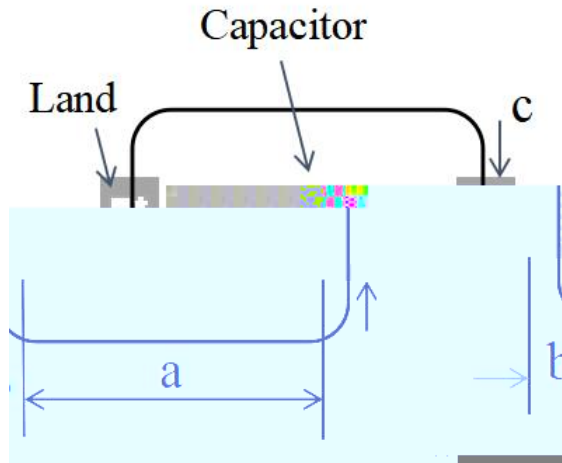

P D	( )	( )	( )
4.3 3.5	4.0	2.2 0.1	3.2 0.1

6. /

6.1 /

280 °  
280°C  
30 °  
30 °  
200 °  
P 200 °  
180 °  
P 180 °

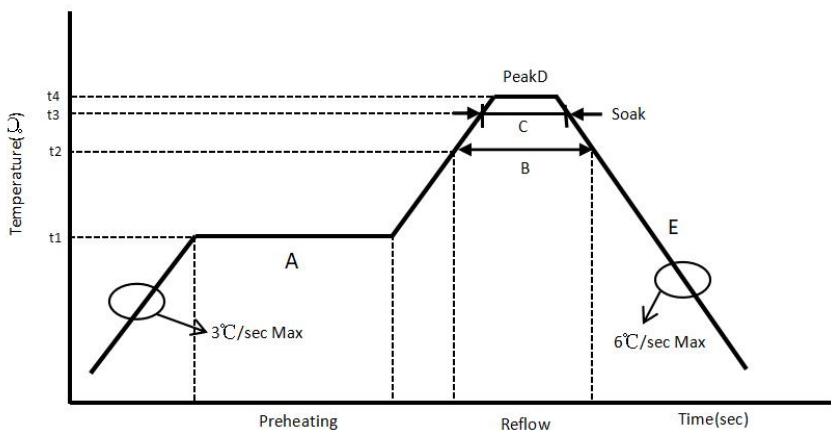

1	175 25	P	A A	120 60
2	215 10		B	110 20%
3	230 10		C C	30 20%
4	275 5	P	D D	20 10

 <b>TRX</b> 专注电容器廿年	- 2 2 . .			
	/	-3-082	/	2021-11-15
	/	A1	/	P 9 18

6.2 /F

280 °  
280°C .

30 °  
30 .

200 °  
200 .

P 200 .

180 °  
180 .

6.3 / I  
PCB/P B

PCB/P B,

400  
- 400 .

50  
50 .

5  
5 .

7. /

NO	I		
1	A	N L L	
2	D	5.1 5.1	



	- 2 2 . .			
	/	-3-082	/	2021-11-15
	/	A1	/	P 10 18

NO	I	
----	---	--

3      O



- 2 2 . .			
/	-3-082	/	2021-11-15
/	A1	/	P 11 18

NO	I			
8				150 180 C 90 30 P 150 180 C 90 30 . / : 230 C-260 C / : 60± 15 . / :4 15--35 45--75% H 24 2 L 15-35 , 45-75% H 24 2 , .
		NO.3 P NO.3		
	C	L:± 10% 5P:± 10% 5 :± 20% 5 :± 20%		
	D.F.	L: 1.0% 5P: 2.5% 5 : 2.5% 5 : 2.5%		
	I .	NO.7 P NO.7		
9		G	( 3 90% ) ( 3 90%), .	(JI K 8101) (JI K 5902) ( 25%) ( ) I (JI K 8101) (JI K 5902) (25%) . ( ) I 2 0.5 2 0.5 . : 245 10 C
10		N		: +125 3
		NO.3 P NO.3		: -40 3
	C	L:± 10% 5P: 10% 5 : 20% 5 : 20%		/ :5
	D.F.	L: 1.0% 5P: 2.5% 5 : 2.5% 5 : 2.5%		30 25 3 24 2
	I .	NO.7 P NO.7		C 25 3 24 2 .



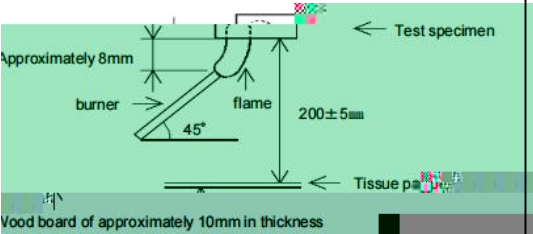

NO	I		
14	I	<p>N</p> <hr/> <p>I</p> <hr/> <p>24 3</p> <p>I 24 3</p> <hr/> <p>I</p>	<p>P : 5.0K</p> <p>I : 10</p> <p>I : 24</p>
15	P	<p>30</p> <p>30 .</p>	<p>30</p> <p>. E</p> <p>: 30 .</p> <p>/L : 12 1</p> <p>35</p> <p>G : L 35 .</p> <p>/I : 0.5 0.1</p> <p>/O : 0.9 .</p> <p>95%</p> <p>G : B 95% .</p>  <p>Approximately 8mm</p> <p>burner</p> <p>flame</p> <p>45°</p> <p>200±5mm</p> <p>Test specimen</p> <p>Tissue paper</p> <p>Wood board of approximately 10mm in thickness</p>

 <b>TRX</b> 专注电容器廿年	- 2 2 . .			
	/	-3-082	/	2021-11-15
	/	A1	/	P 14 18

NO	I		
16	C	N P NO.3 NO.7 N .3 N .7	:30± 5% 70± 5% :30± 5% 70± 5% / :23 5 5± 0.5 5 0.5 / :8
17			:30± 5% 70± 5% :30± 5% 70± 5% / :23 5 5± 0.5 10 5 0.5 10

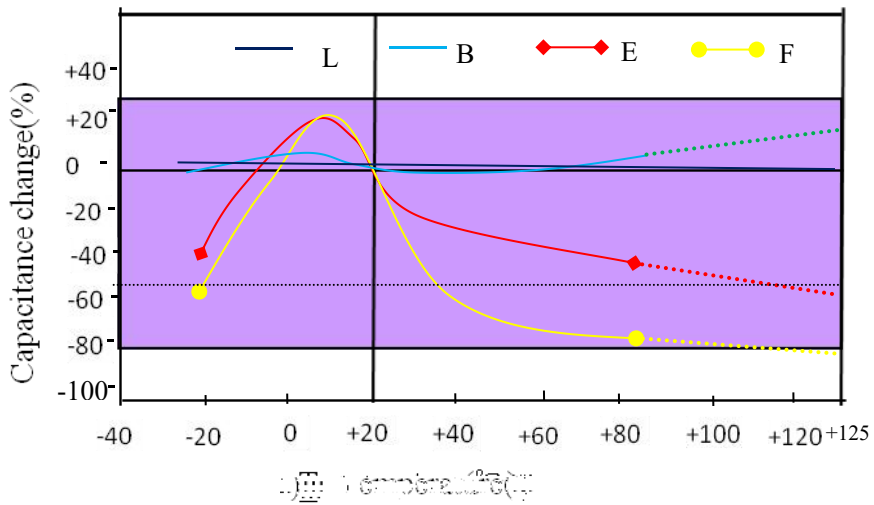
8. /



	- 2 2 . .			
	/	-3-082	/	2021-11-15
	/	A1	/	P 15 18

9. /

H 2.0 2011/65/E

EACH N 190 7/2006



	( ; )
/C	<100
/L	<1000
/M	<1000
/H	<1000
PBB /P	<1000
PBDE /P	<1000
+ + + /C +P +H +C +6( )	<100
/C	<900
/B	<900
+ /C +B	<1500
EACH H C HC ( HC) EACH	EACH

10. /

(1).

E ; , , , ,  
 . A , , , , , ,

(2).

12

12

(3).

/ : 10 30  
 /H : 60%

168

(4).

6

60 × 168

I

6

HIC

(60 168 )

 <b>TRX</b> 专注电容器廿年	- 2 2 . .			
	/	-3-082	/	2021-11-15
	/	A1	/	P 16 18

11. /  
11.1 /D

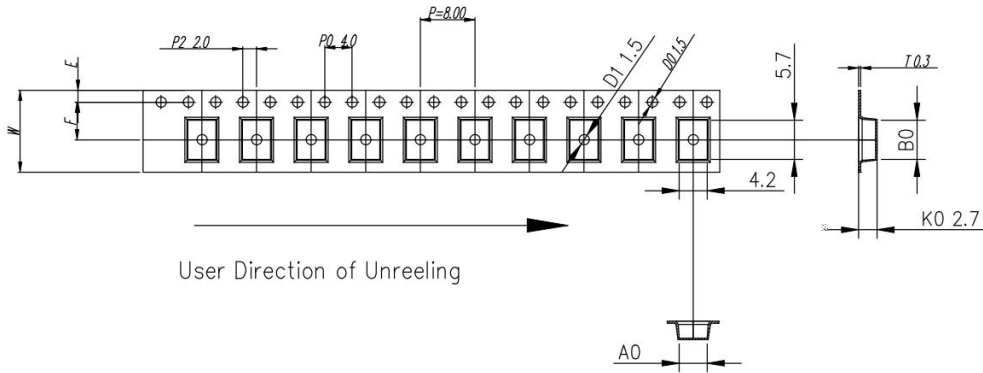

ITEM	W	A0	B0	K1	K0	P	F	E	D0	D1	P0	P2	T
DIM	12.0	$4.38^{+0.10/-0.30}$	$5.70^{+0.10/-0.10}$	--	$2.70^{+0.10/-0.10}$	8.00	$5.50^{+0.10/-0.10}$	1.75	$1.5^{+0.10/-0.10}$	$1.5^{+0.10/-0.10}$	4.0	2.0	0.30
ALTERNATE													

11.2 /D

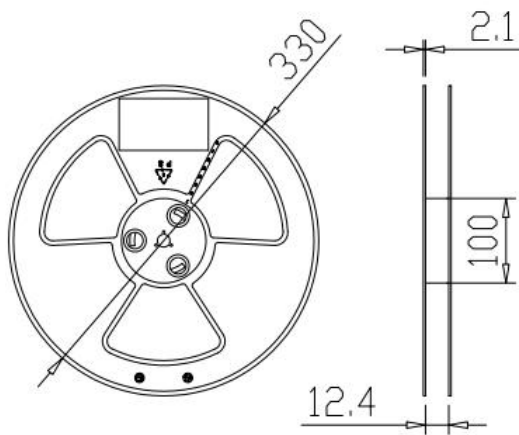

EEL	EEL I E
3000	13



11.3 /P

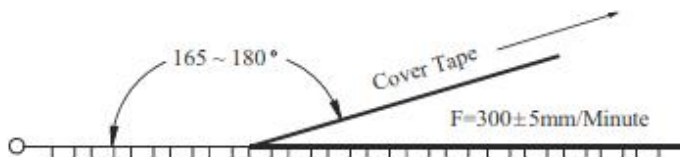



Item	Data	Remark
Cover tape adhesion	10 ~ 100g	Carrier tape and cover tape open angle 165 ~ 180° F=300±5mm/minute

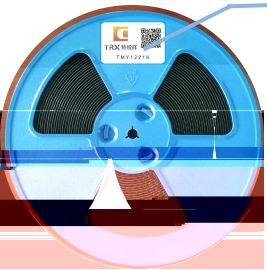



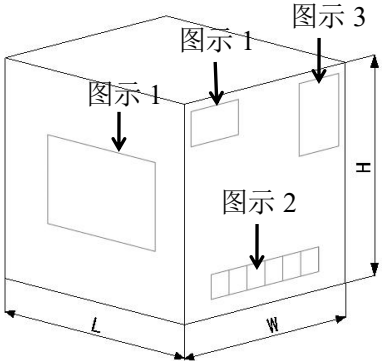

 <b>TRX</b> 专注电容器廿年	- 2 2 . .			
	/	-3-082	/	2021-11-15
	/	A1	/	P 17 18

11.4 /P P

/ -	 标签/L		 料号		/I	
/ : 13 3.0KPC /					.D	
						P/N
						M
						D/C
						L .N
						PEC

/ -								
	图示 1/F 1	图示 2/F 2	图示 3/F 3					
			D ( )		O B			
L	355	H	294	45KPC		10.0KG		

/ :								
/O B	15	/ /15	/B	( / / )		( / / )		
				P (L/ /H)		(L/ /H)		
				1100*1100*90		1100*1100*1600		

1. " 5"	5	2. PALLE & APPING	
3. 50 :1. 5	4. /	5	; 2. P & -
		; 3.50	; 4. N



	- 2 2 . .			
	/	-3-082	/	2021-11-15
	/	A1	/	P 18 18

12. /

①.

A

②.

PCB

PCB

PCB

C

C