



深圳市弗瑞鑫电子有限公司

规格承认书

—

prepare	
check	
approve	



TRX电容一级代理商

深圳市弗瑞鑫电子有限公司

Add:深圳市宝安区西乡大道302号金源商务大厦B座3楼

Tel:0755-29563634

Fax:0755-27447020

 TRX 专注电容器廿年	SMD Y SMD Y1 a.c. ceramic capacitors			
	/Number		/Date	
	/Edition		/Page	

	SMD Y SMD Y1 a.c. ceramic capacitors		
	/Number		/Date
	/Edition		/Page

1. /Product Name



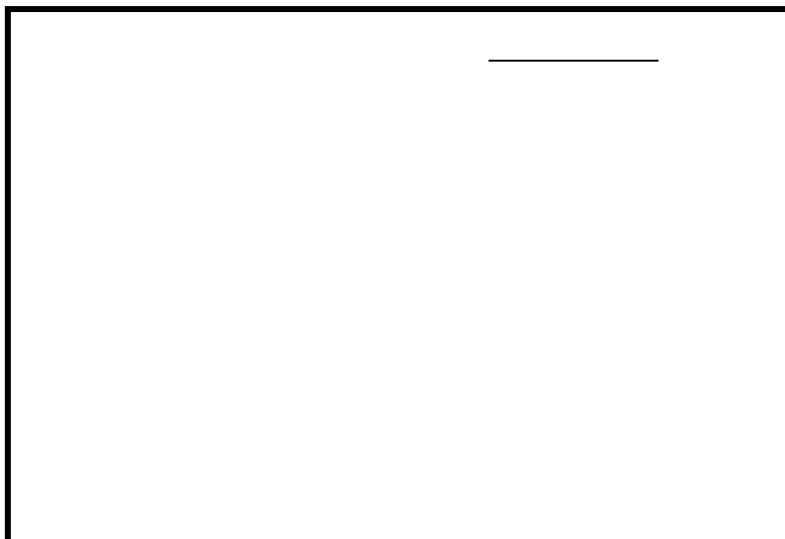
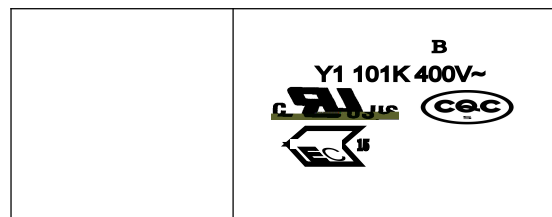

T M Y1 101 K
 ① ② ③ ④ ⑤

①		
②		
③		
④		
⑤		

2. /Product marking



 <p>TRX 专注电容器廿年</p>	SMD Y SMD Y1 a.c. ceramic capacitors		
	/Number		/Date
	/Edition		/Page

/Explanation	
	
	
	
	
	

3. /Date code

↓	↓				
		↓	↓		

4. /Certificates

certificates			

5. /Product structure

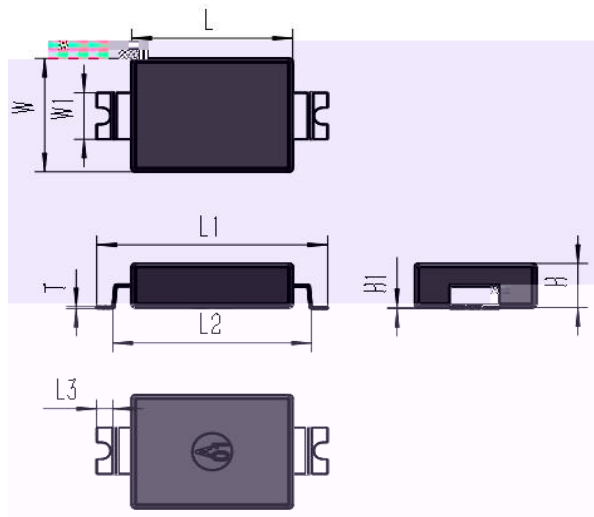

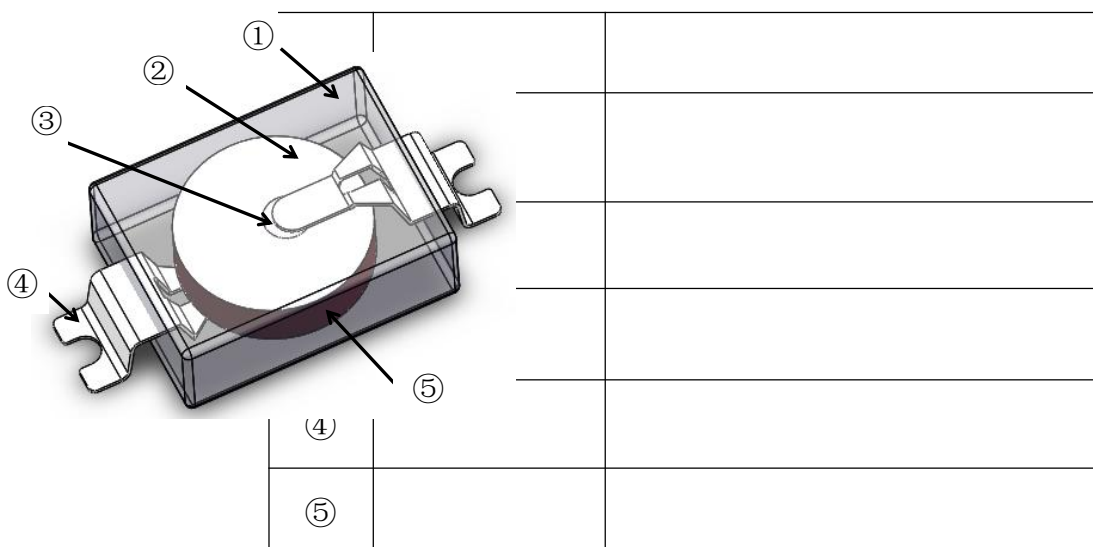

/Number		/Date	
/Edition		/Page	

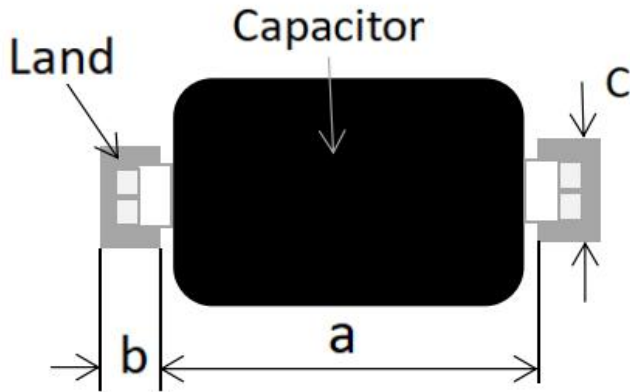

6. / Soldering condition

/

°
°C
°
°

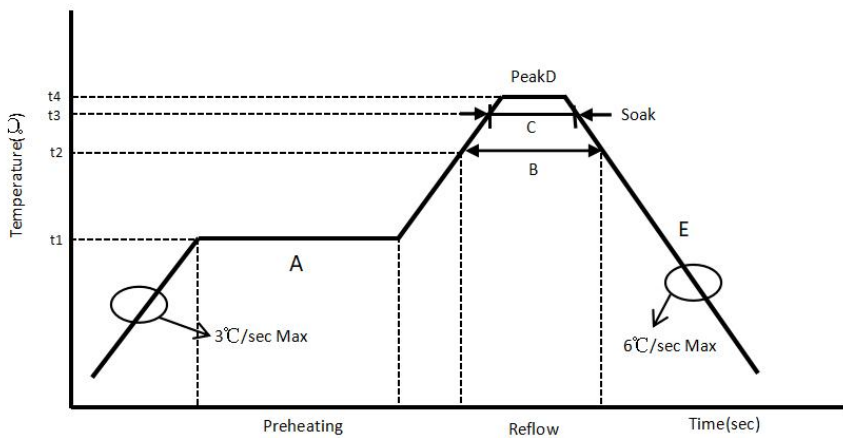

	SMD Y SMD Y1 a.c. ceramic capacitors		
	/Number		/Date
	/Edition		/Page

/

°
°C
°
°
°

/

7. / Performance and test methods

SMD Y
SMD Y1 a.c. ceramic capacitors



/Number

/Date

/Edition

/Page

		△	
		△	
		△	
		△	
		△	
		△	
		△	
		△	
		△	
		△	

SMD Y
SMD Y1 a.c. ceramic capacitors





/Number

/Date

/Edition

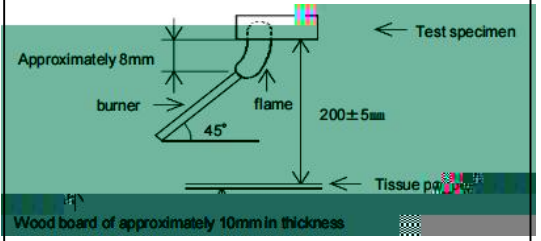
/Page



 TRX 专注电容器廿年	SMD Y SMD Y1 a.c. ceramic capacitors		
	/Number		/Date
	/Edition		/Page



 TRX 专注电容器廿年	SMD Y		
	SMD Y1 a.c. ceramic capacitors		
	/Number		/Date
	/Edition		/Page

11. /Product Packing

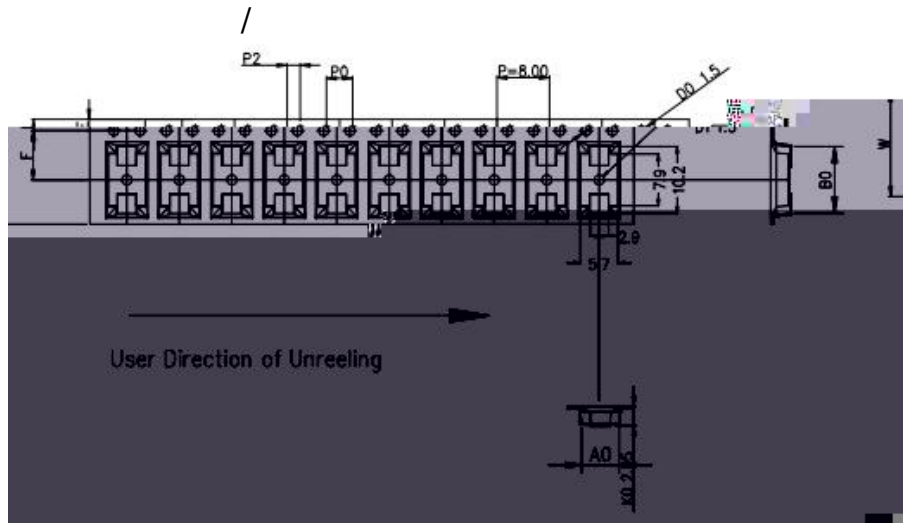

ITEM	Δ W	A0	B0	K1	K0	P	F	E	D0	D1	P0	P2	T
DIM	16.0 +0.30 -0.10	5.70 +0.10 -0.10	10.20 +0.10 -0.10	---	2.95 +0.10 -0.10	8.00 +0.10 -0.10	7.50 +0.10 -0.10	1.75 +0.18 -0.18	ϕ 1.5 +0.10 -0.00	ϕ 1.5 +0.10 -0.00	4.0 +0.10 -0.10	2.0 +0.10 -0.10	0.30 +0.05 -0.05
ALTERNATE													

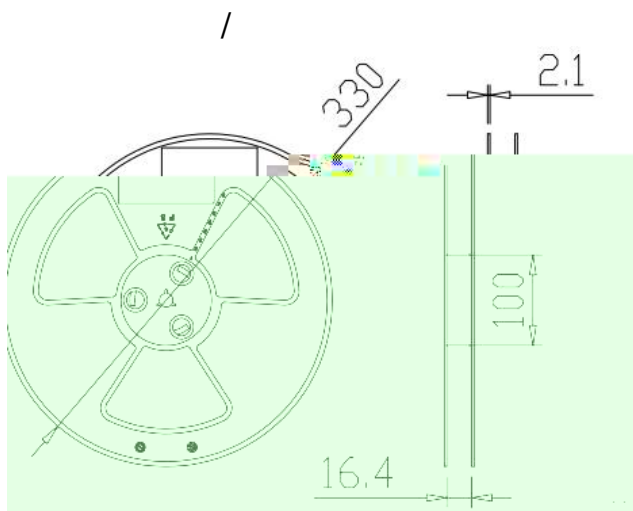

Item	Data	Remark
Cover tape adhesion	10 ~ 100g	Carrier tape and cover tape open angle 165 ~ 180° F=300±5mm/minute

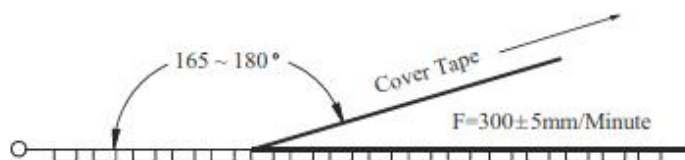

 TRX 专注电容器廿年	SMD Y		
	SMD Y1 a.c. ceramic capacitors		
	/Number		/Date
/Edition		/Page	

/inner-packaging

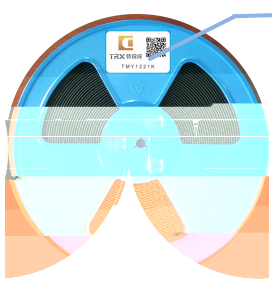

标签



料号





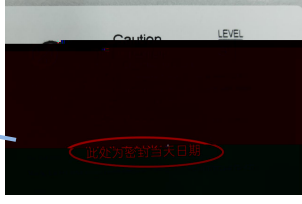

此处为密封的关闭期

/Outer-packaging





图示 / 图示 /



图示 /

/Package sketch:



/



/





Remark

	SMD Y SMD Y1 a.c. ceramic capacitors		
	/Number		/Date
	/Edition		/Page

12. /Application notes

①

②

③

④

⑤

⑥