

S8550

TRANSISTOR(PNP)

FEATURES

Complimentary to S8050

Collector current: $I_C=0.5A$

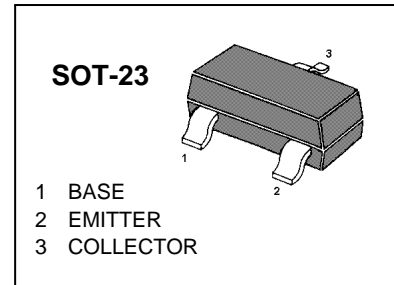

MARKING : 2TY

MAXIMUM RATINGS ($T_A=25^\circ C$ unless otherwise noted)

| Symbol | Parameter | Value | Units |
|-----------|-------------------------------|---------|------------|
| V_{CBO} | Collector-Base Voltage | -40 | V |
| V_{CEO} | Collector-Emitter Voltage | -25 | V |
| V_{EBO} | Emitter-Base Voltage | -5 | V |
| I_C | Collector Current -Continuous | -0.5 | A |
| P_C | Collector Power Dissipation | 0.3 | W |
| T_j | Junction Temperature | 150 | $^\circ C$ |
| T_{stg} | Storage Temperature | -55-150 | $^\circ C$ |

ELECTRICAL CHARACTERISTICS ($T_{amb}=25^\circ C$ unless otherwise specified)

| Parameter | Symbol | Test conditions | MIN | MAX | UNIT |
|--------------------------------------|---------------|--|-----|------|---------|
| Collector-base breakdown voltage | $V_{(BR)CBO}$ | $I_C = -100\mu A, I_E=0$ | -40 | | V |
| Collector-emitter breakdown voltage | $V_{(BR)CEO}$ | $I_C = -1mA, I_B=0$ | -25 | | V |
| Emitter-base breakdown voltage | $V_{(BR)EBO}$ | $I_E = -100\mu A, I_C=0$ | -5 | | V |
| Collector cut-off current | I_{CBO} | $V_{CB} = -40V, I_E=0$ | | -0.1 | μA |
| Collector cut-off current | I_{CEO} | $V_{CE} = -20V, I_B=0$ | | -0.1 | μA |
| Emitter cut-off current | I_{EBO} | $V_{EB} = -3V, I_C=0$ | | -0.1 | μA |
| DC current gain | $h_{FE(1)}$ | $V_{CE} = -1V, I_C = -50mA$ | 200 | 350 | |
| | $h_{FE(2)}$ | $V_{CE} = -1V, I_C = -500mA$ | 50 | | |
| Collector-emitter saturation voltage | $V_{CE(sat)}$ | $I_C = -500mA, I_B = -50mA$ | | -0.6 | V |
| Base-emitter saturation voltage | $V_{BE(sat)}$ | $I_C = -500mA, I_B = -50mA$ | | -1.2 | V |
| Transition frequency | f_T | $V_{CE} = -6V, I_C = -20mA$ $f=30MHz$ | 150 | | MHz |

Typical Characteristics

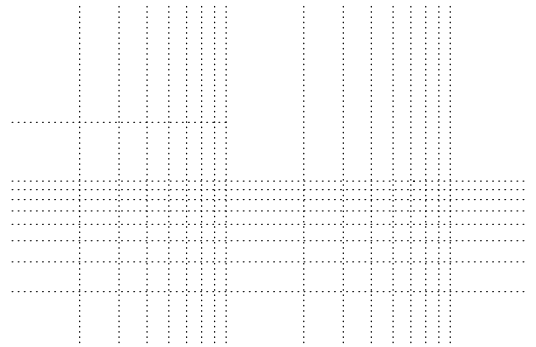
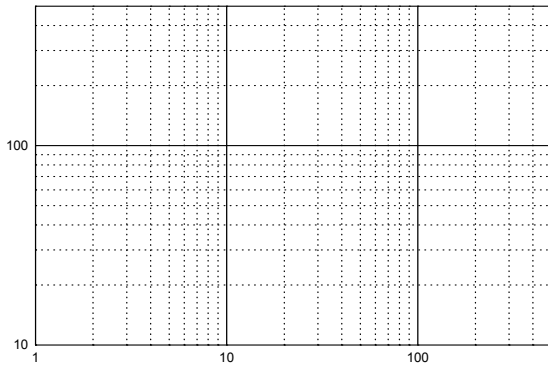
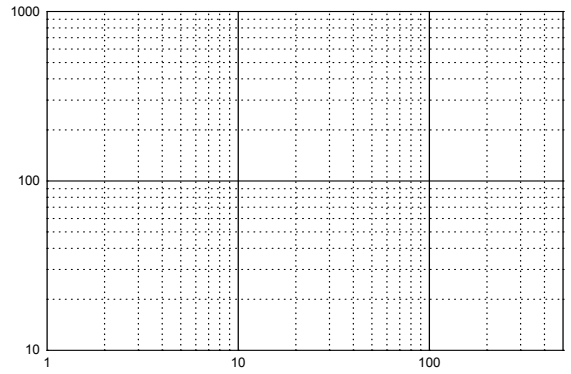

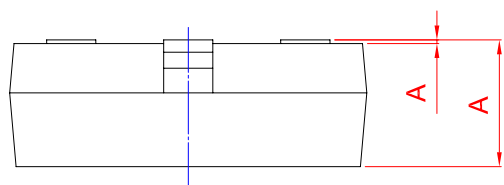
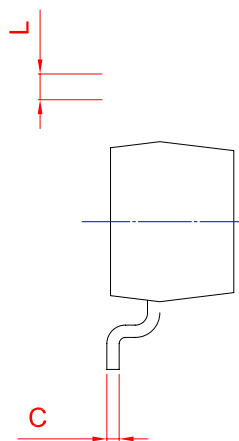
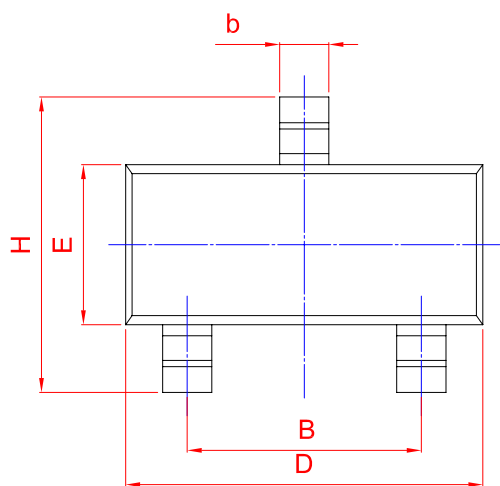

| | | | | | | | | | |
|-------------|-----------|--|--|--|---|---|--|----------------|--|
| UNIT | A | | | | D | E | | A ₁ | |
| mm | 1.40 (| | | | | | | | |