

深圳市弗瑞鑫电子有限公司

规格承认书

/Specification for approval

客户名 /CUSTOMER :

客户 号/CUSTOMER P. N. _____

号/TRX P. N. _____

型号/MODEL NO. _____

产 品	RoHS	REACH	Halogen 卤
保	■	■	■

制作/prepare	客户 () /customer to confirm (signed)
审 /check	
批准/approve	(后, 惠 壹份) /(signed subscription, please also one copy)



TRX电容一级代理商

深圳市弗瑞鑫电子有限公司

Add:深圳市宝安区西乡大道302号金源商务大厦B座3楼

Tel:0755-29563634

Fax:0755-27447020

- 2

2 . .

/	-3-082	/	2021-11-15
/	A1	/	P 3 18

	- 2 2 . .			
	/	-3-082	/	2021-11-15
	/	A1	/	P 4 18

/CON EN

1.	P	N	-----	5
2.	P		-----	5-6
3.	D		-----	6
4.	C		-----	7
5.	P		-----	7-8
6.			-----	8-9
7.	P		-----	9-14
8.	C		-----	14
9.	C		-----	15
10.			-----	15
11.	P	P	-----	16-17
12.	A		-----	18

	- 2 2 . .			
	/	-3-082	/	2021-11-15
	/	A1	/	P 5 18

1. /

① ② ③ ④ ⑤ ⑥

N . C

E

①

L

	- 2 2 . .			
	/	-3-082	/	2021-11-15
	/	A1	/	P 6 18

3. /



		2020	M	1	01	1	01	16	16
		2021	N	2	02	2	02	17	17
2010	A	2022	P	3	03	3	03	18	18
2011	B	2023		4	04	4	04	19	19
2012	C	2024		5	05	5	05	20	20
2013	D	2025		6	06	6	06	21	21
2014	E	2026		7	07	7	07	22	22
2015	F	2027		8	08	8	08	23	23
2016	H	2028		9	09	9	09	24	24
2017	J	2029		10	10	10	10		

4. /

C		C	C
L/C L	L/C A 60384-14	E315719	AC300 (. . .)
C C	GB/ 6346.14-2015	C C20001280609	AC300 (. . .)
ENEC	EN 60384-14:2013/A1:2016	ENEC-03177	AC300 (. . .)
KC	K60384-14	H 03034-21003A	AC250 (. . .)

5. /

5.1 /P D

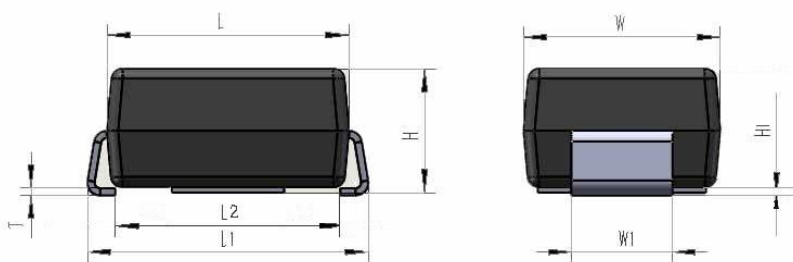

P		D		()	
L	4.3 0.1			3.5 0.3	
L1	5.0 0.1	L2		4.0 0.1	
H	2.2 0.1	1		1.8 0.05	
H1	0.1 0.05			0.13 0.02	

5.2 /P

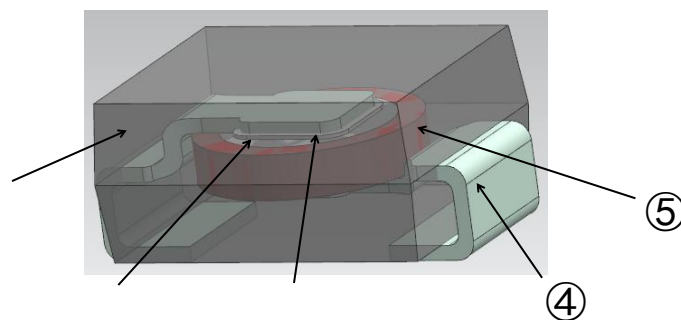

N .	P	M
①	C	E (L94 -0) (L94 -0)
②	E	/C
③		-P -A -P -A
④	L P	
⑤	D	C

- 2
2 . .

/

-3-082

/

2021-11-15

/

]] ~~CONFIDENTIAL~~ 199 TT 2Sw / FT14 199 TT 200 TD((U)) 5199 TT 2 0 TD((U))

	- 2 2 . .			
	/	-3-082	/	2021-11-15
	/	A1	/	P 9 18

6.2 /F

280 °
280°C .

30 °
30 .

200 °
200 .

P 200 .

180 °
180 .

6.3 / I
PCB/P B

PCB/P B,

400
- 400 .

50
50 .

5
5 .

7. /

NO	I		
1	A	N L L	
2	D	5.1 5.1	

 TRX 专注电容器廿年	- 2 2 . .			
	/	-3-082	/	2021-11-15
	/	A1	/	P 10 18

NO	I	
----	---	--

3 #A





- 2 2 . .			
/	-3-082	/	2021-11-15
/	A1	/	P 11 18

NO	I		
8			150 180 C 90 30 P 150 180 C 90 30 . / . : 230 C-260 C / : 60± 15 . / :4 15--35 45--75% H 24 2 L 15-35 , 45-75% H 24 2 , .
		NO.3 P NO.3	
	C	L:± 10% 5P:± 10% 5 :± 20% 5 :± 20%	
	D.F.	L: 1.0% 5P: 2.5% 5 : 2.5% 5 : 2.5%	
	I .	NO.7 P NO.7	
9		G	(90%) 3 (90%), 3 I (JI K 5902) (JI K 8101) 25%) () 5902) (25%) (JI K 8101) (JI K) . () I 2 0.5 2 0.5 . : 245 10 C
10		N	
		NO.3 P NO.3	: +125 3
	C	L:± 10% 5P: 10% 5 : 20% 5 : 20%	: -40 3 / : 5
	D.F.	L: 1.0% 5P: 2.5% 5 : 2.5% 5 : 2.5%	30 25 3 24 2
	I .	NO.7 P NO.7	C 25 3 24 2 .

NO	I		
16	C	N P NO.3 NO.7 N .3 N .7	$30 \pm 5\%$ $70 \pm 5\%$ $30 \pm 5\%$ $70 \pm 5\%$ / : 23 5 5 ± 0.5 5 ± 0.5 . / : 8
17			$30 \pm 5\%$ $70 \pm 5\%$ $30 \pm 5\%$ $70 \pm 5\%$ / : 23 5 5 ± 0.5 10 5 ± 0.5 10 .

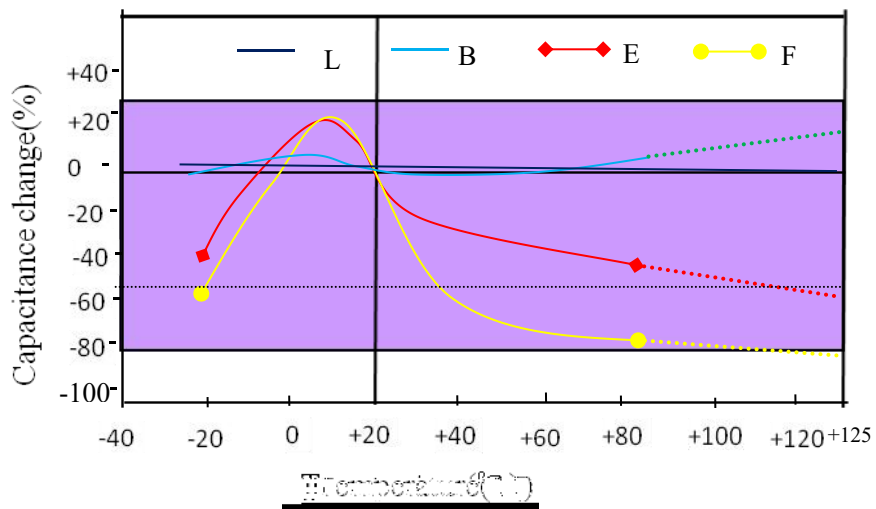
8. /



	- 2 2 . .			
	/	-3-082	/	2021-11-15
	/	A1	/	P 15 18

9. /

H 2.0 2011/65/E

EACH N 190 7/2006



	(;)
/C	<100
/L	<1000
/M	<1000
/H	<1000
PBB /P	<1000
PBDE /P	<1000
+ + + /C +P +H +C +6()	<100
/C	<900
/B	<900
+ /C +B	<1500
EACH H C HC (HC) EACH	EACH

10. /

(1).

E ; , , , ,
. A , , , , , ,

(2).

12 , 12

(3).

/ : 10 30
/H : 60% .

168

(4).

6

60 × 168

I

6

HIC

(60 168)

 TRX 专注电容器廿年	- 2 2 . .			
	/	-3-082	/	2021-11-15
	/	A1	/	P 16 18

11. /
11.1 /D

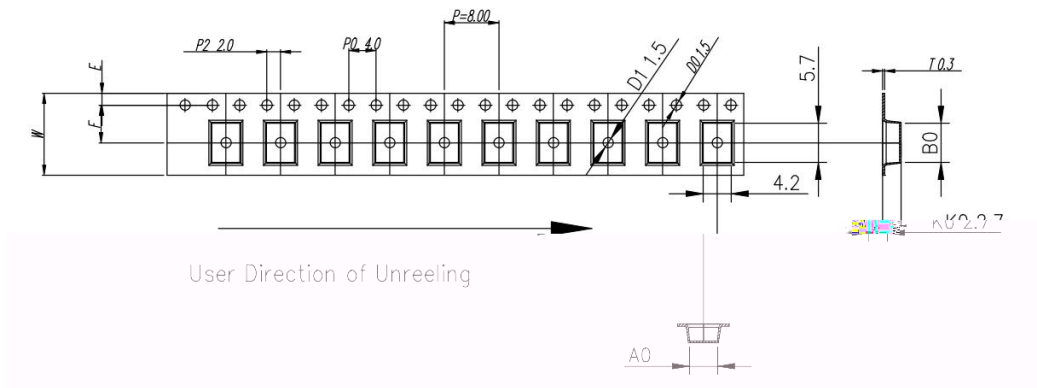

ITEM	W	A0	B0	K1	K0	P	F	E	D0	D1	P0	P2	T
DIM	12.0 ±0.30	4.2 ±0.10	5.70 ±0.10	--	2.70 ±0.10	8.00 ±0.10	5.50 ±0.10	1.75 ±0.10	1.5 ±0.00	1.5 ±0.10	4.0 ±0.10	2.0 ±0.10	0.30 ±0.05
ALTERNATE													

11.2 /D

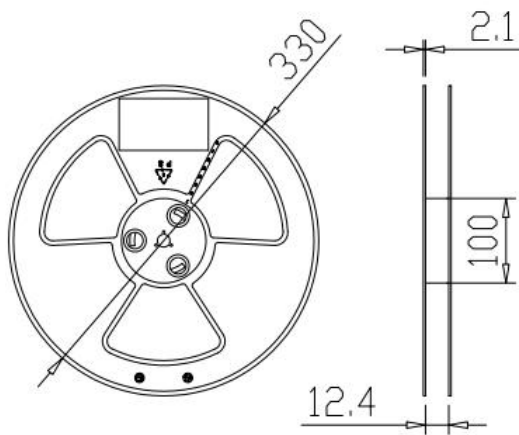

EEL	EEL I E
3000	13



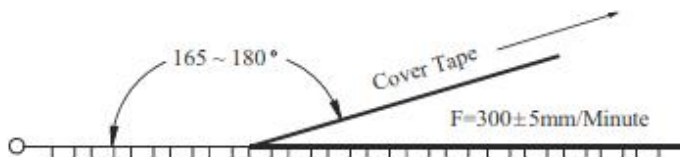

11.3 /P



Item	Data	Remark
Cover tape adhesion	10 ~ 100g	Carrier tape and cover tape open angle 165 ~ 180° F=300±5mm/minute

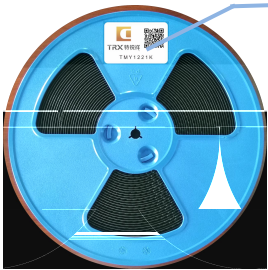

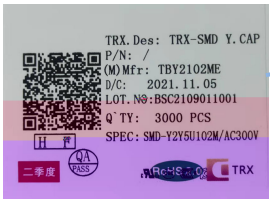

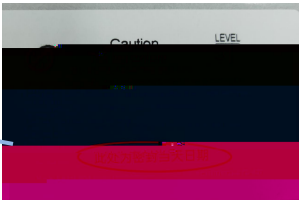

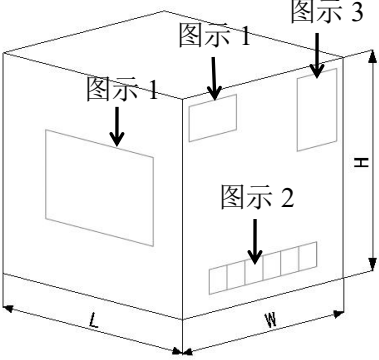
 TRX 专注电容器廿年	- 2			
	2 . .			
	/	-3-082	/	2021-11-15
	/	A1	/	P 17 18

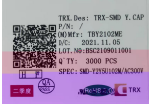
11.4 /P P

 <p>标签/L</p>  <p>料号</p> <p>3.0KPC /</p>   	/I	
	.D	
	P/N	
	M	
	D/C	
	L .N	
/P	/L	/H
PEC		

 <p>图示 1/F 1</p> <p>图示 2/F 2</p> <p>图示 3/F 3</p>			
D ()	O B		
L 355	H 294	45KPC	10.0KG

 <p>/O B</p>	 <p>15 / /15 /B</p>	 <p>(/ /)</p> <p>P (L/ /H)</p> <p>1100*1100*90</p>	 <p>(/ /)</p> <p>(L/ /H)</p> <p>1100*1100*1600</p>
---	--	--	---

1. " 5" 5 2. PALLE & APPING

3.50 :1. 5 4. / ' 5 ; 2. P & -

; 3.50 ; 4. N

	- 2 2 . .			
	/	-3-082	/	2021-11-15
	/	A1	/	P 18 18

12. /

①.

A

②.

PCB

PCB

PCB

C

(PCB)

PCB

PCB

③.

A

④.

P

⑤.

D

PCB

⑥.

D

PCB

PC